

FS6400-10-10-O

Steel, SAE J1453 O-Ring Face Seal Port Connector, 5/8" Male ORFS x 7/8-14 Male ORB

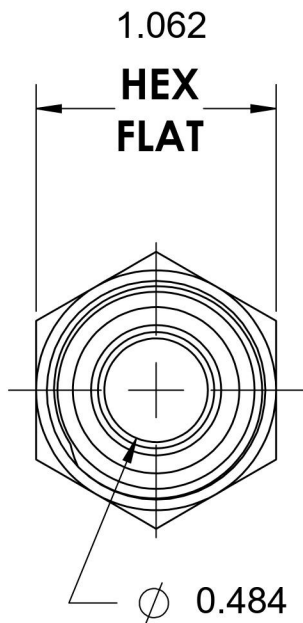

1-14 UNS

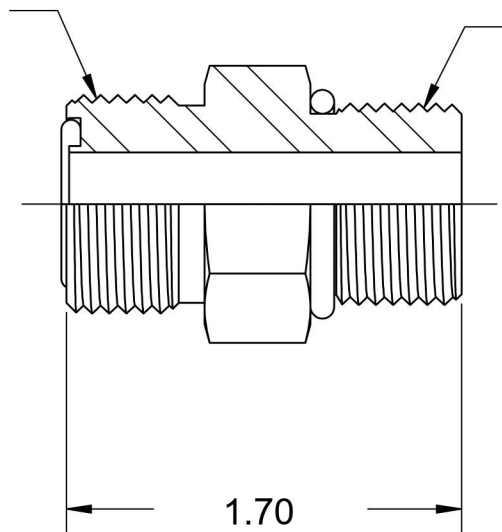

7/8-14 UNF

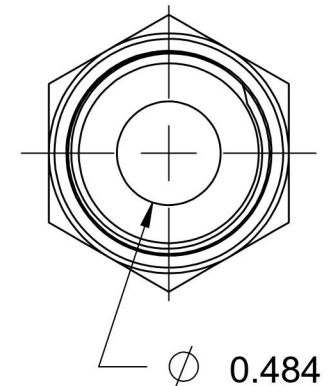

6701 Cochran Road
Solon, Ohio 44139
Phone: (440) 248-1880
Toll Free: 1-888-331-1523

Temperature Rating

-40°F to 250°F

Pressure Rating

6000 psi

Material

C1045 / 12L14 Steel

Finish

Trivalent Zinc

Industry Standards

SAE J1453, SAE J1926-2
ASTM B633

Series

FS6400-O

Series Description

SAE J1453 O-Ring Face Seal
Port Connector