

7012-12-10

Steel, SAE J514 37° Flare Male BSPP Type (G) Port Connector, 3/4" Male JIC x 5/8-14 Male BSPP ORR

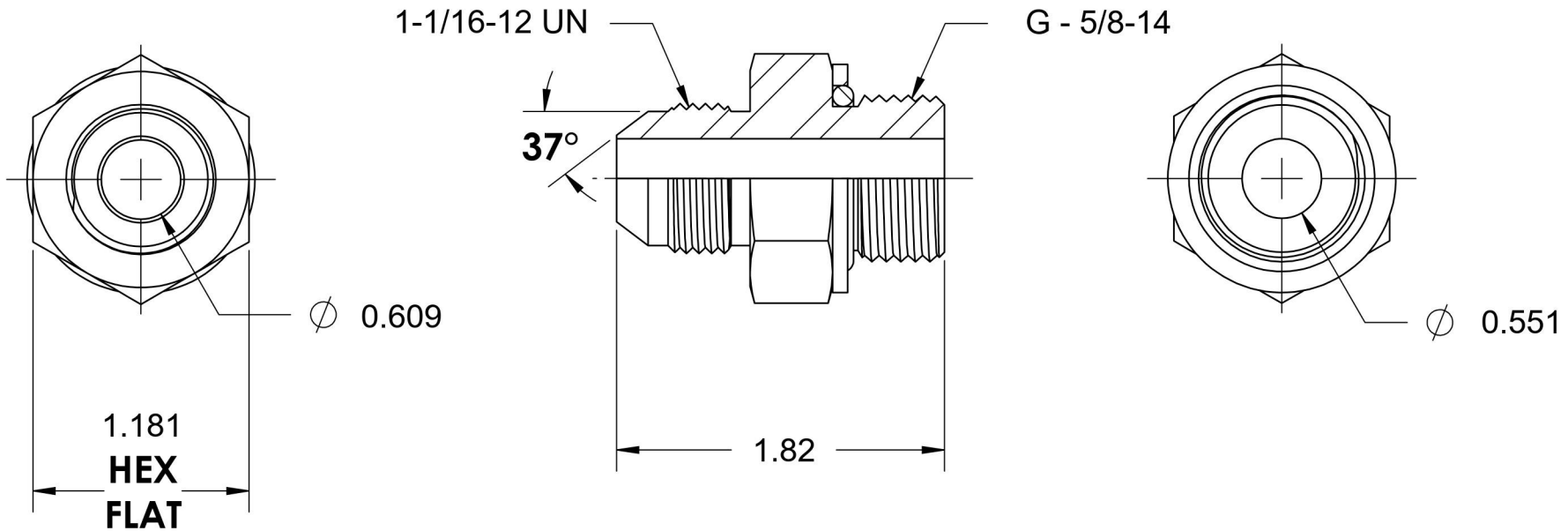

6701 Cochran Road
Solon, Ohio 44139
Phone: (440) 248-1880
Toll Free: 1-888-331-1523

Temperature Rating

-40°F to 250°F

Pressure Rating

4000 psi

Material

C1045 / 12L14 Steel

Finish

Trivalent Zinc

Industry Standards

SAE J514, ISO 1179

ASTM B633

Series

7012-ORR

Series Description

SAE J514 37° Flare Male
BSPP Type (G) Port Connector