

2601-08-08-04-FG

Steel, SAE J514 SAE J514 37° Flare Male Branch Tee, 1/2" Male JIC x 1/2" Male JIC x 1/4" Male NPTF 30°

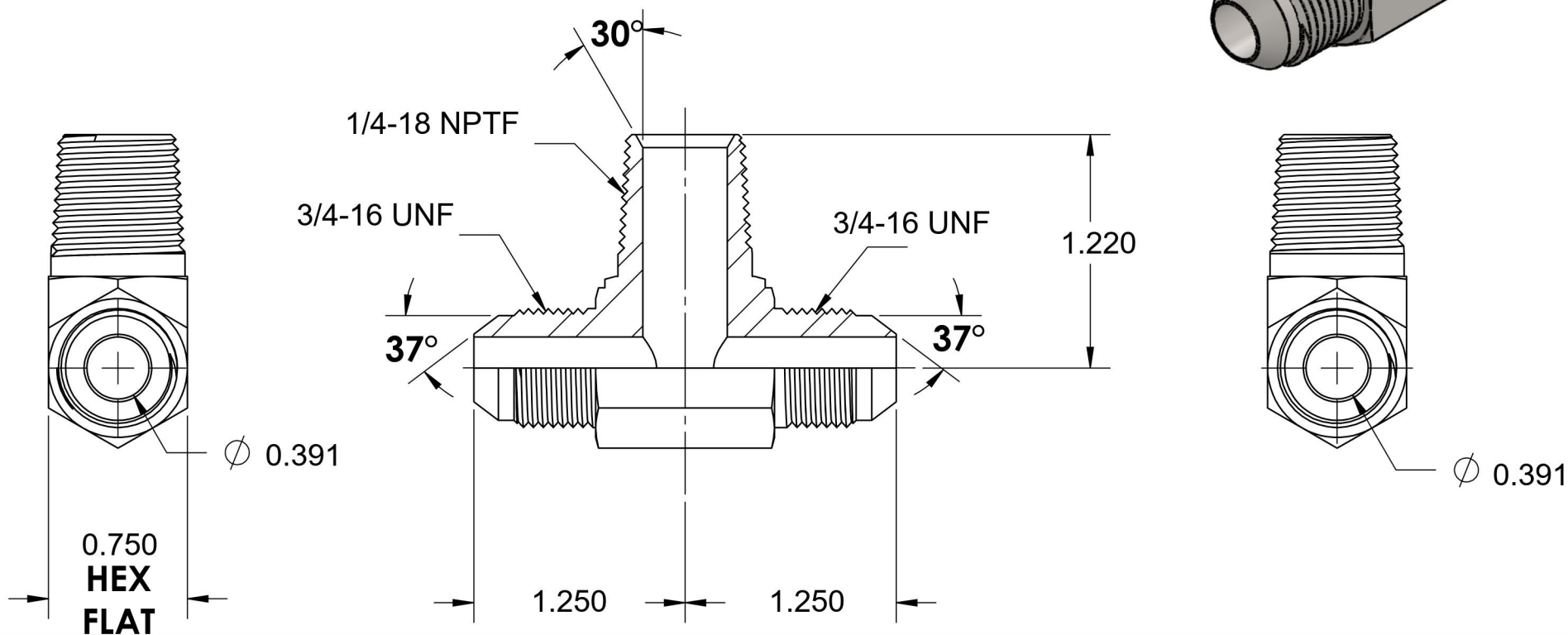
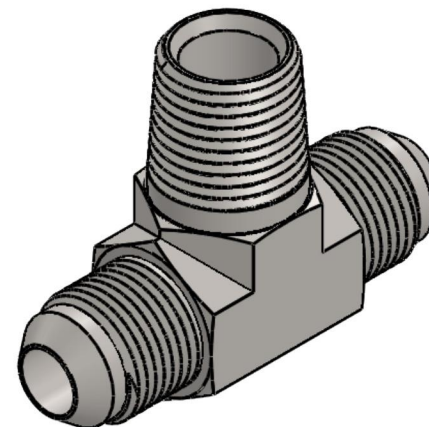
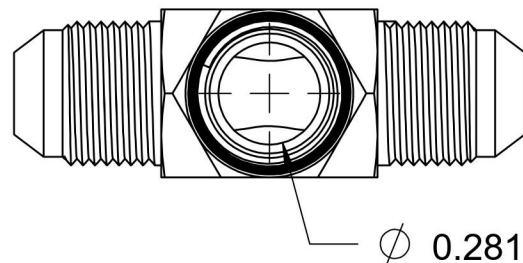

6701 Cochran Road
Solon, Ohio 44139
Phone: (440) 248-1880
Toll Free: 1-888-331-1523

Temperature Rating -65°F to 500°F	Material C1045 Steel	Industry Standards SAE J514 , SAE J476	Series 2601-FG
Pressure Rating 6000 psi	Finish Trivalent Zinc		Series Description SAE J514 37° Flare Male Branch Tee