

7017-08-08

Steel, ISO 1179 Female BSPG Gauge Port Connector, 1/2-14 Male BSPG 60° Line/Port x 1/2-14 Female BSPG Gauge Port

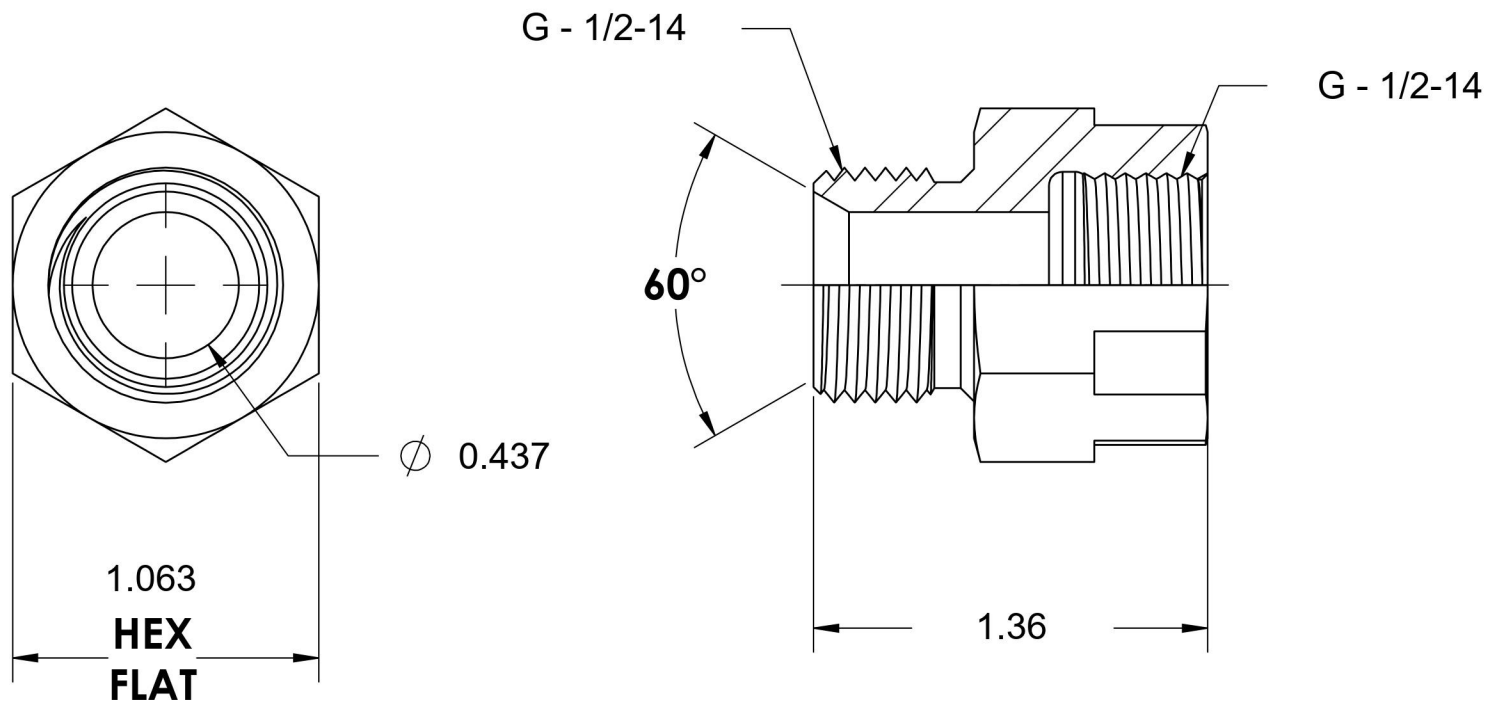
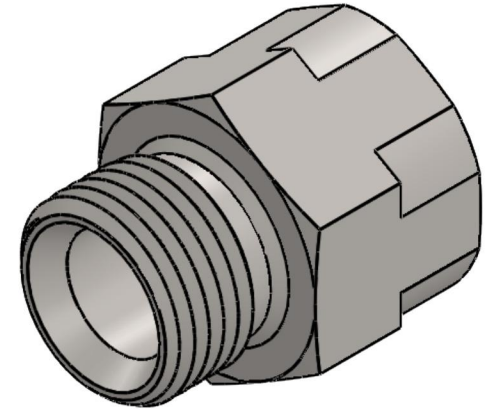

6701 Cochran Road
Solon, Ohio 44139
Phone: (440) 248-1880
Toll Free: 1-888-331-1523

Temperature Rating -65°F to 500°F	Material C1045 / 12L14 Steel	Industry Standards ISO 1179, ISO 8434-6 DIN 3852-2 ASTM B633	Series 7017
Pressure Rating 2900 psi	Finish Trivalent Zinc	Series Description ISO 1179 Female BSPG Gauge Port Connector	