

# 6901-16-12-NWO-FG

Steel, SAE J514 NPSM Swivel 90° Adjustable Port Elbow, 1-5/16-12 Male Adjustable ORB x 3/4" Female NPSM Swivel

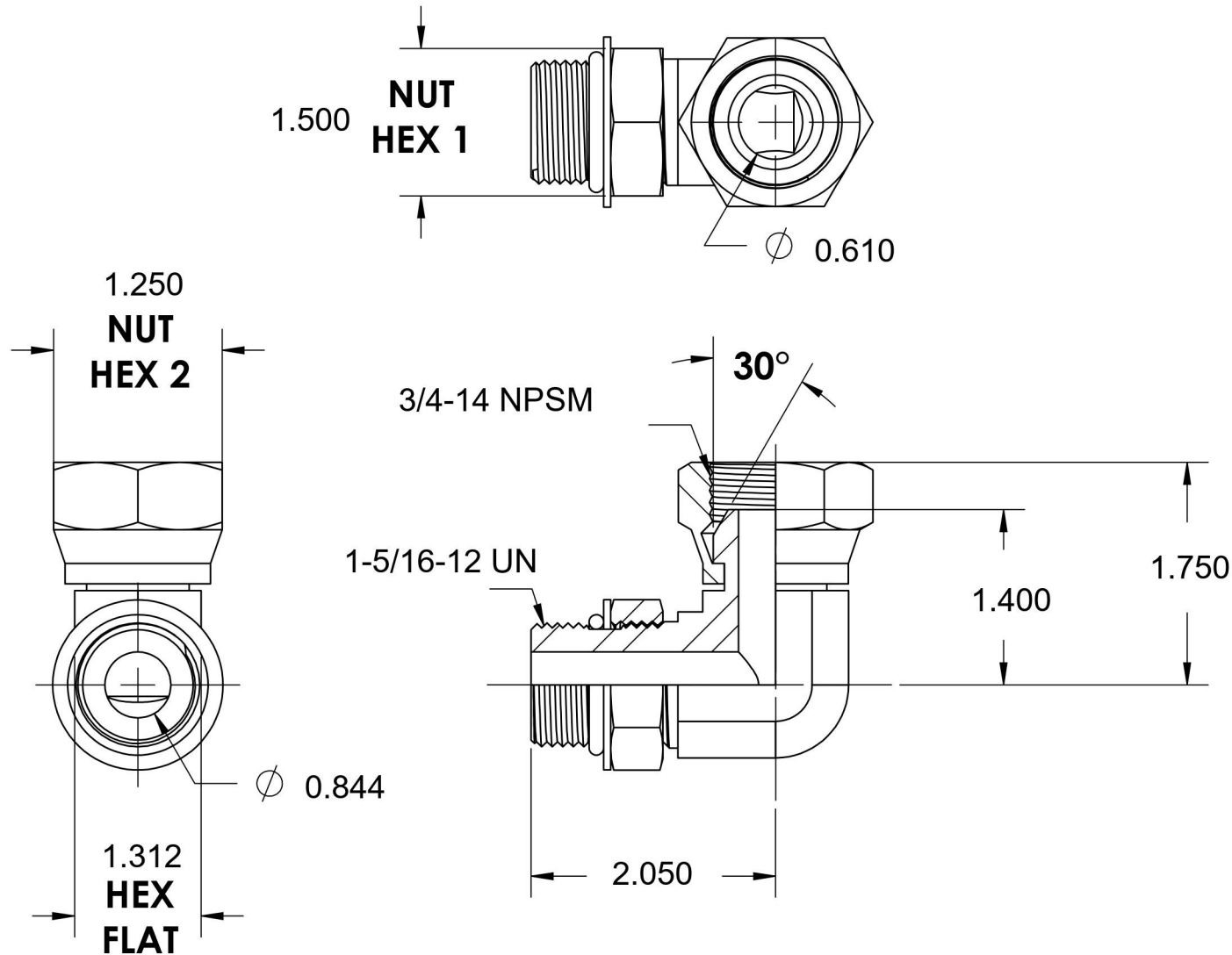

6701 Cochran Road  
Solon, Ohio 44139  
Phone: (440) 248-1880  
Toll Free: 1-888-331-1523

**Temperature Rating**

-40°F to 250°F

**Pressure Rating**

3000 psi

**Material**

C1045 Steel

**Finish**

Trivalent Zinc

**Industry Standards**

SAE J514, SAE J1926-3  
SAE J515, ASTM B633

**Series**

6901-NWO-FG

**Series Description**

SAE J514 NPSM Swivel 90° Adjustable Port Elbow