

2700-LN-06-04-SS

Stainless Steel, SAE J514 37° Flare Bulkhead With Lock Nut, 3/8" Male JIC x 1/4" Male JIC

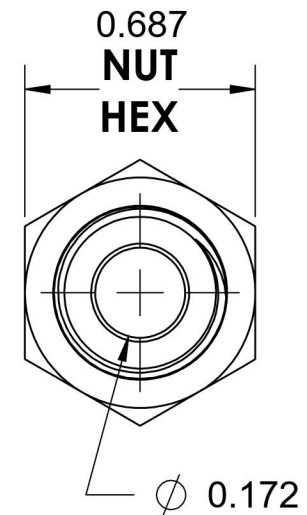
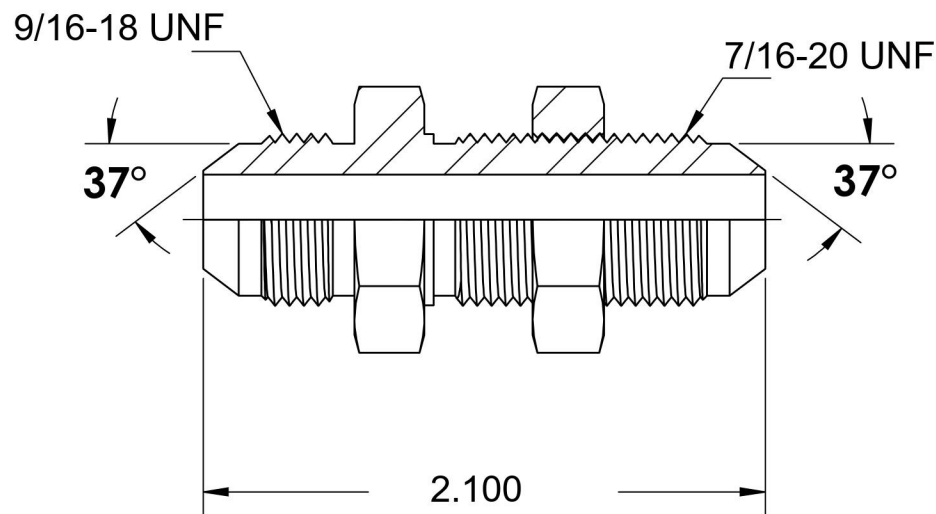
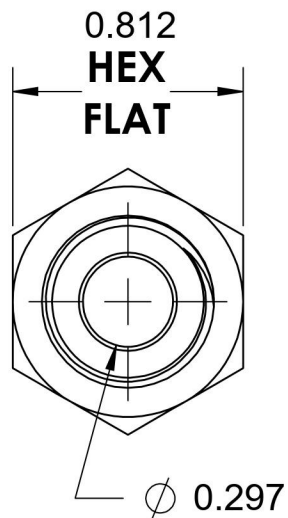
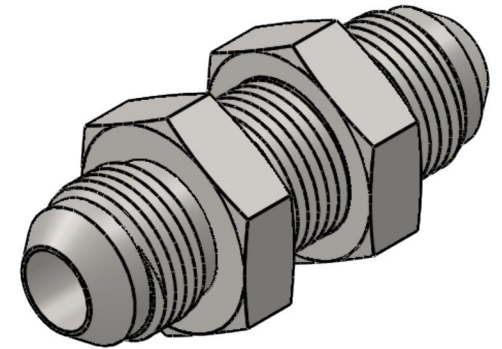

6701 Cochran Road
Solon, Ohio 44139
Phone: (440) 248-1880
Toll Free: 1-888-331-1523

Temperature Rating	-425°F to 1200°F	Material	316/316L Stainless Steel	Industry Standards	SAE J514	Series	2700-LN-SS
Pressure Rating	7200 psi	Finish	Passivated			Series Description	SAE J514 37° Flare Bulkhead With Lock Nut