

6400-32-20-O

Steel, SAE J514 37° Flare Port Connector, 2" Male JIC x 1-5/8-12 Male ORB

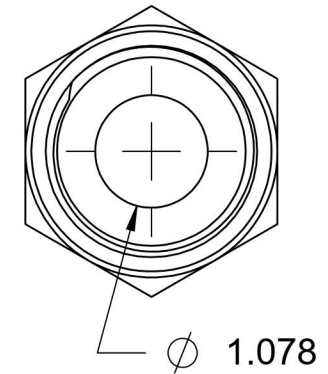
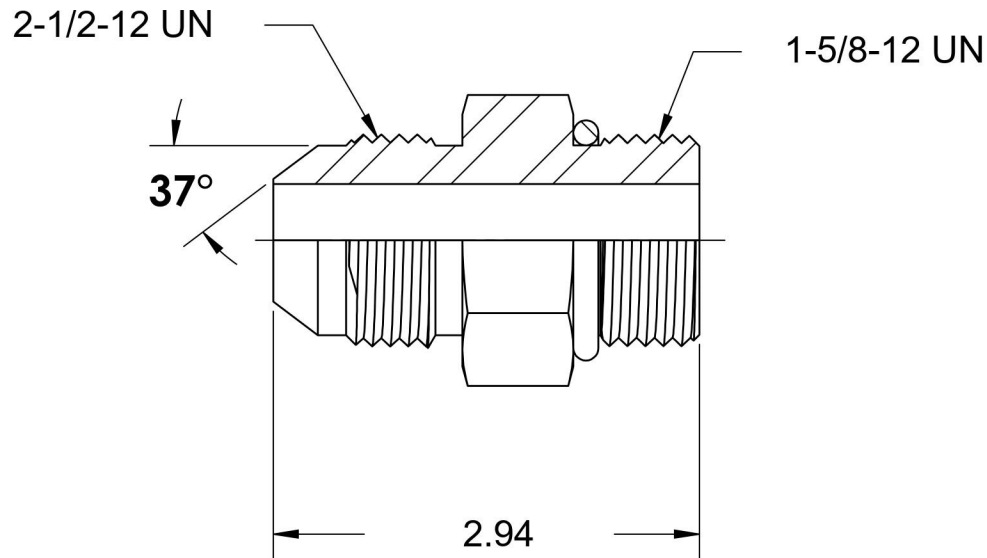
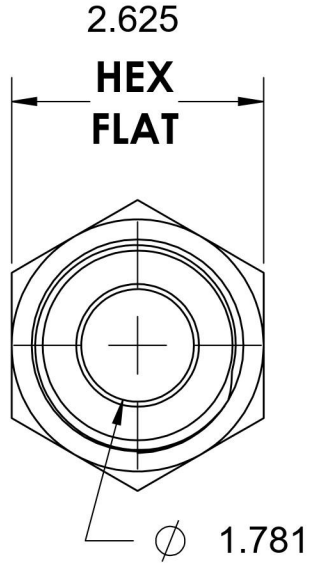

6701 Cochran Road
Solon, Ohio 44139
Phone: (440) 248-1880
Toll Free: 1-888-331-1523

Temperature Rating
-40°F to 250°F

Pressure Rating
2000 psi

Material
C1045 / 12L14 Steel

Finish
Trivalent Zinc

Industry Standards
SAE J514, SAE J1926-3
ASTM B633

Series
6400-O

Series Description
SAE J514 37° Flare Port Connector