

# 2501-08-04-B

Brass, SAE J514 37° Flare 90° Male Elbow, 1/2" Male JIC x 1/4" Male NPTF 30°

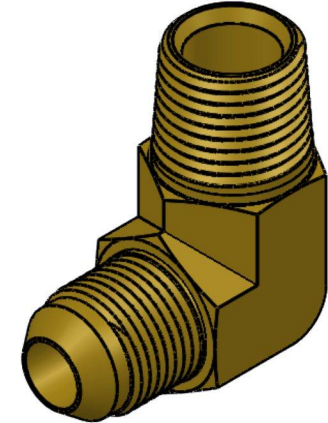
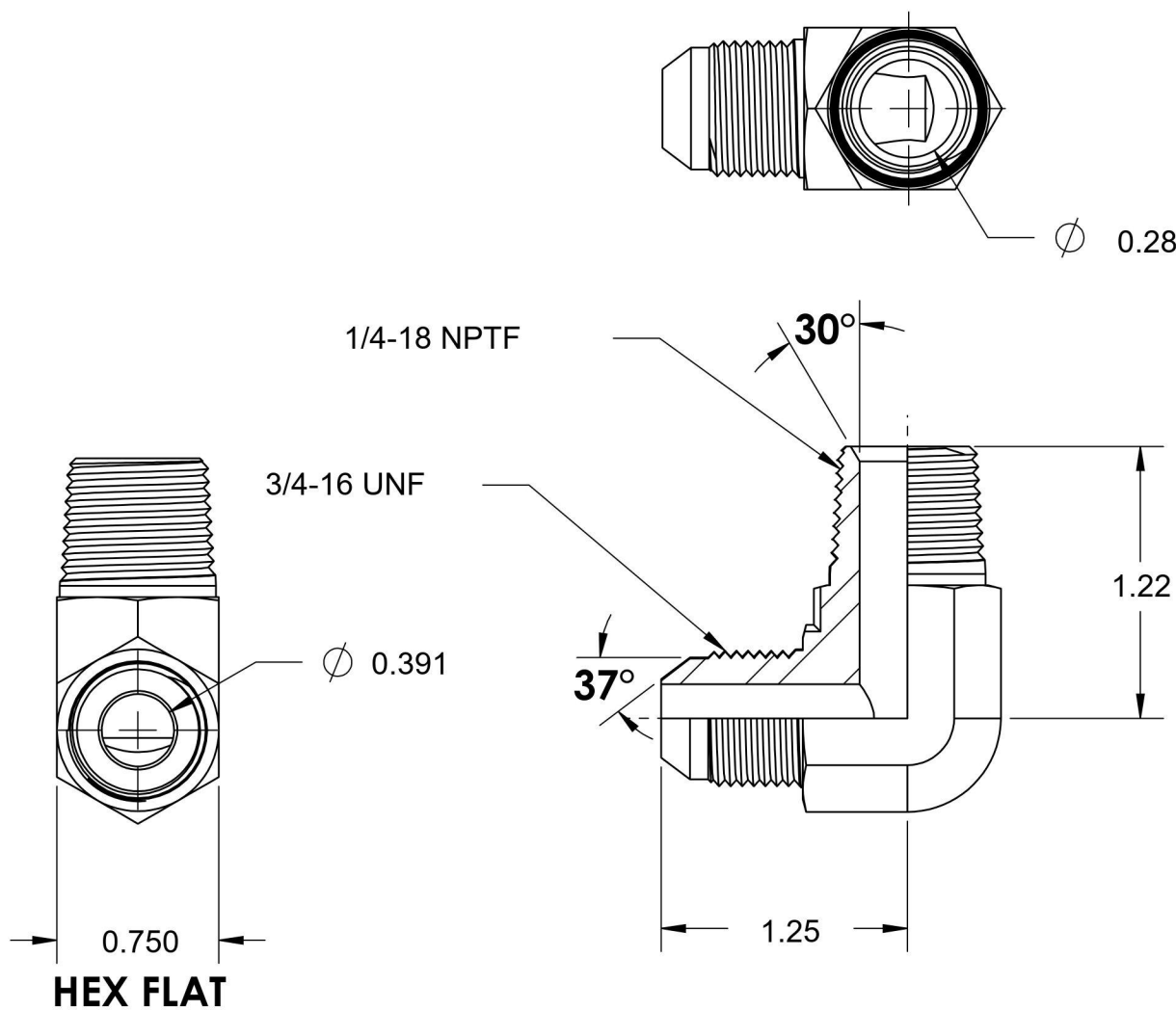

6701 Cochran Road  
Solon, Ohio 44139  
Phone: (440) 248-1880  
Toll Free: 1-888-331-1523

**Temperature Rating**

-325°F to 400°F

**Pressure Rating**

3300 psi

**Material**

CA377 Brass

**Finish**

Natural Finish

**Industry Standards**

SAE J514, SAE J476

**Series**

2501-B

**Series Description**

SAE J514 37° Flare 90° Male Elbow