

FS0304-C-06-SS

Stainless Steel, SAE J1453 O-Ring Face Seal Cap, 3/8" ORFS Cap

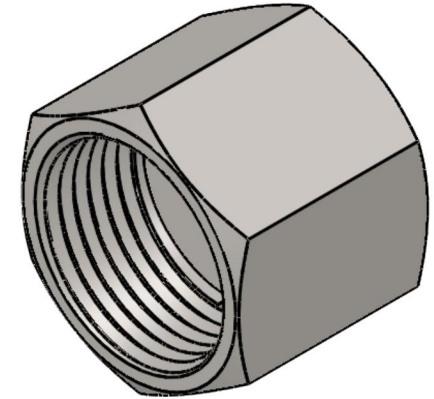
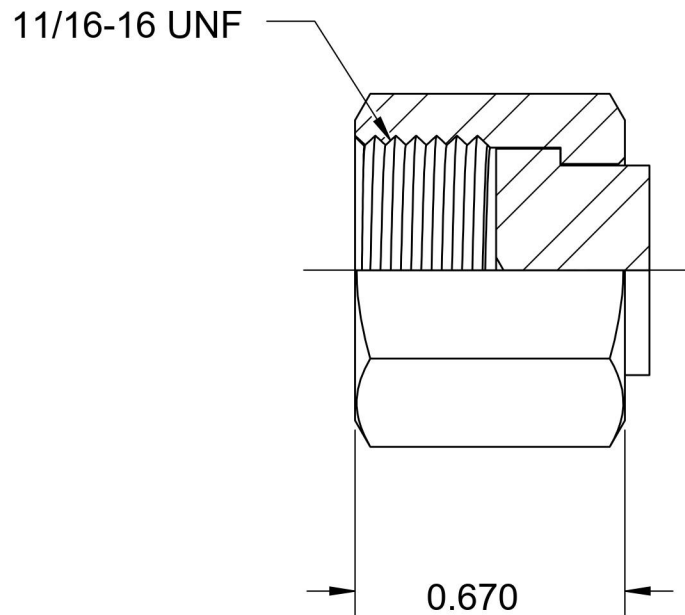
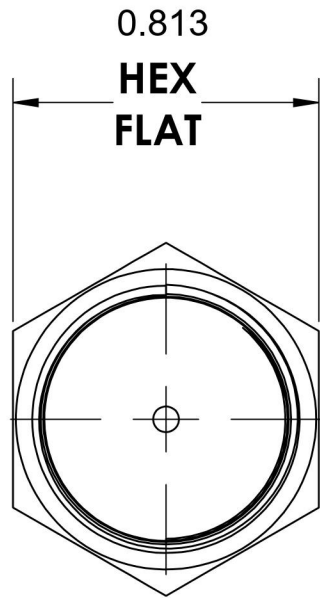

6701 Cochran Road
Solon, Ohio 44139
Phone: (440) 248-1880
Toll Free: 1-888-331-1523

Temperature Rating	Material	Industry Standards SAE J1453	Series FS0304-C-SS
-425°F to 1200°F	316/316L Stainless Steel		
Pressure Rating	Finish		Series Description
9200 psi	Passivated		SAE J1453 O-Ring Face Seal Cap