

C2404-04-04

Steel, SAE J514 Flareless Tube Male Connector, 1/4" Flareless Bite Type x 1/4" Male NPTF 30°

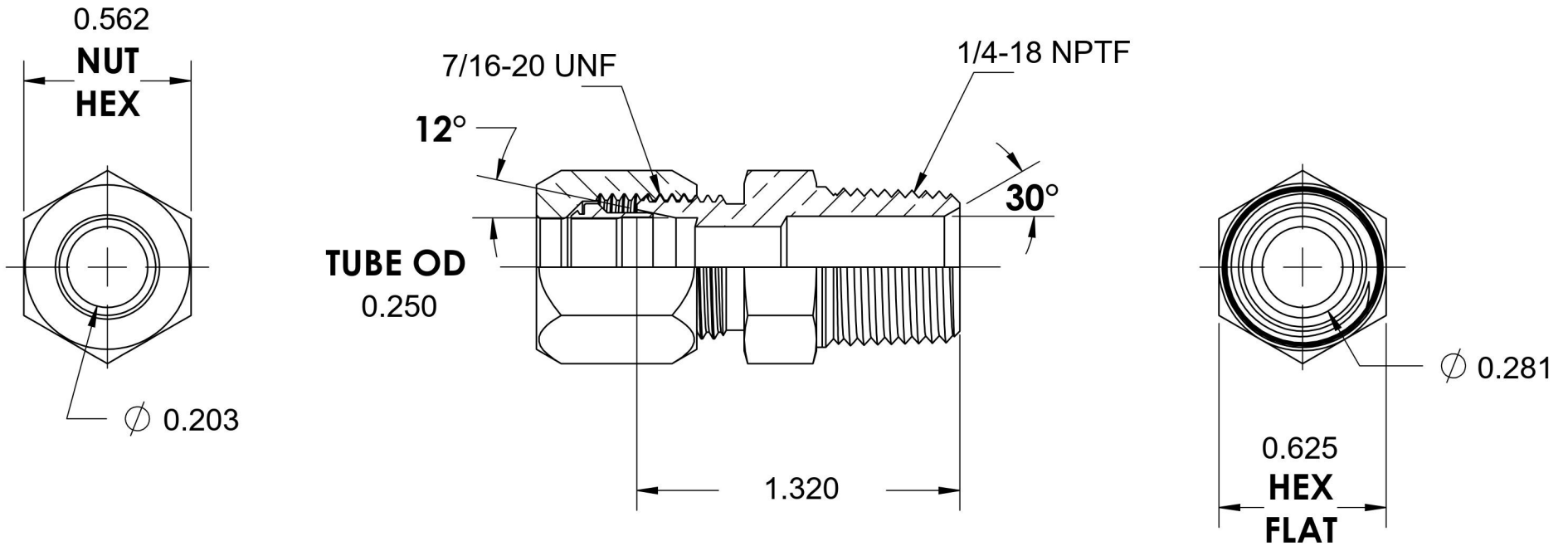
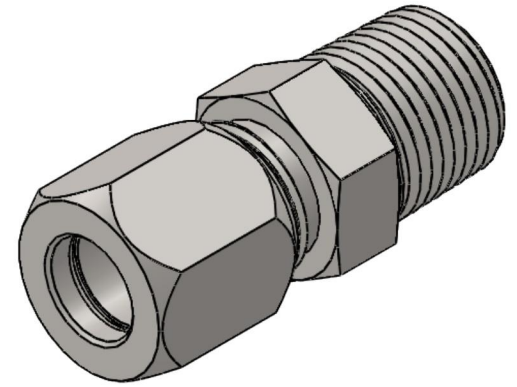

6701 Cochran Road
Solon, Ohio 44139
Phone: (440) 248-1880
Toll Free: 1-888-331-1523

Temperature Rating

-65°F to 500°F

Pressure Rating

6000 psi

Material

C1045/12L14 Steel

Finish

Trivalent Zinc

Industry Standards

SAE J514, SAE J476
ASTM B633

Series

C2404

Series Description

SAE J514 Flareless Tube
Male Connector