

C6400-16-12-O

Steel, SAE J514 Flareless Tube Port Connector, 1" Flareless Bite Type x 1-1/16-12 Male ORB

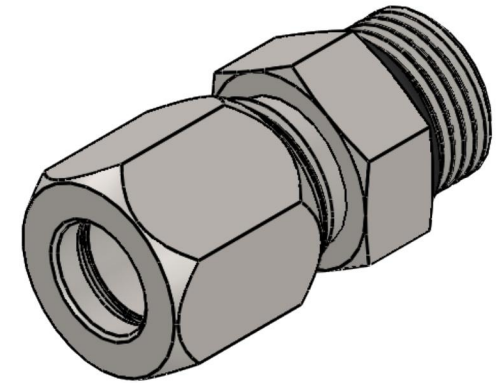

6701 Cochran Road
Solon, Ohio 44139
Phone: (440) 248-1880
Toll Free: 1-888-331-1523

Temperature Rating	Material	Industry Standards	Series
-40°F to 250°F	C1045 Steel	SAE J514, SAE J1926 ASTM B633	C6400-O
Pressure Rating	Finish		Series Description
4000psi	Trivalent Zinc		SAE J514 Flareless Tube Port Connector