

# 6502-14-14-FG

Steel, SAE J514 37° Flare 45° Swivel Elbow, 7/8" Male JIC x 7/8" Female JIC Swivel

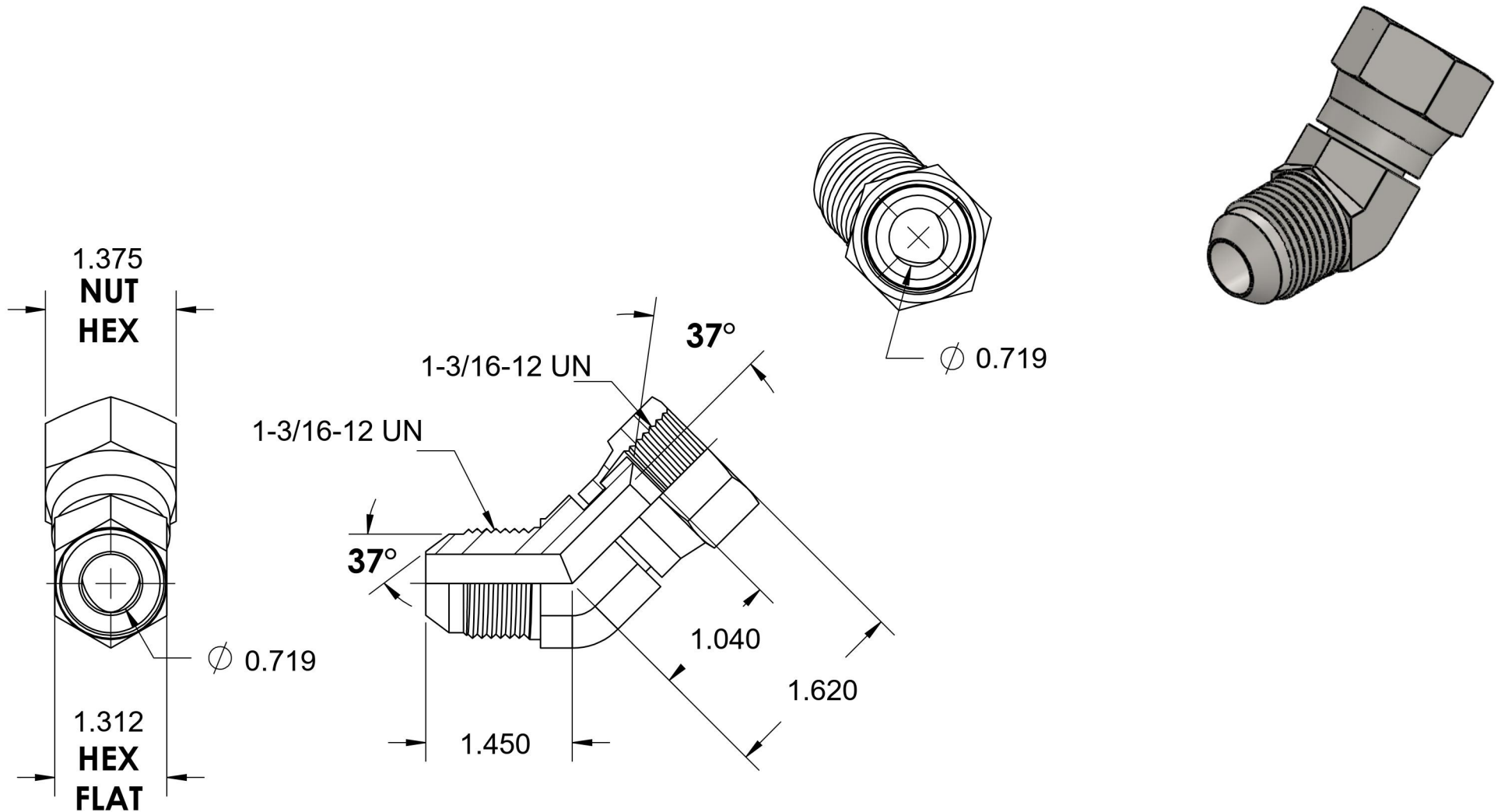

6701 Cochran Road  
Solon, Ohio 44139  
Phone: (440) 248-1880  
Toll Free: 1-888-331-1523

<b>Temperature Rating</b>	<b>Material</b>	<b>Industry Standards</b>	<b>Series</b>
-65°F to 500°F	C1045 Steel	SAE J514, ASTM B633	6502-FG
<b>Pressure Rating</b>	<b>Finish</b>	<b>Series Description</b>	
5000 psi	Trivalent Zinc	SAE J514 37° Flare 45° Swivel Elbow	