

# 1804-16-24-SS

Stainless Steel, SAE J514 37° Flare Code 62 Flange 90° Swept Elbow, 1" Male JIC x 1-1/2" Split Flange Head

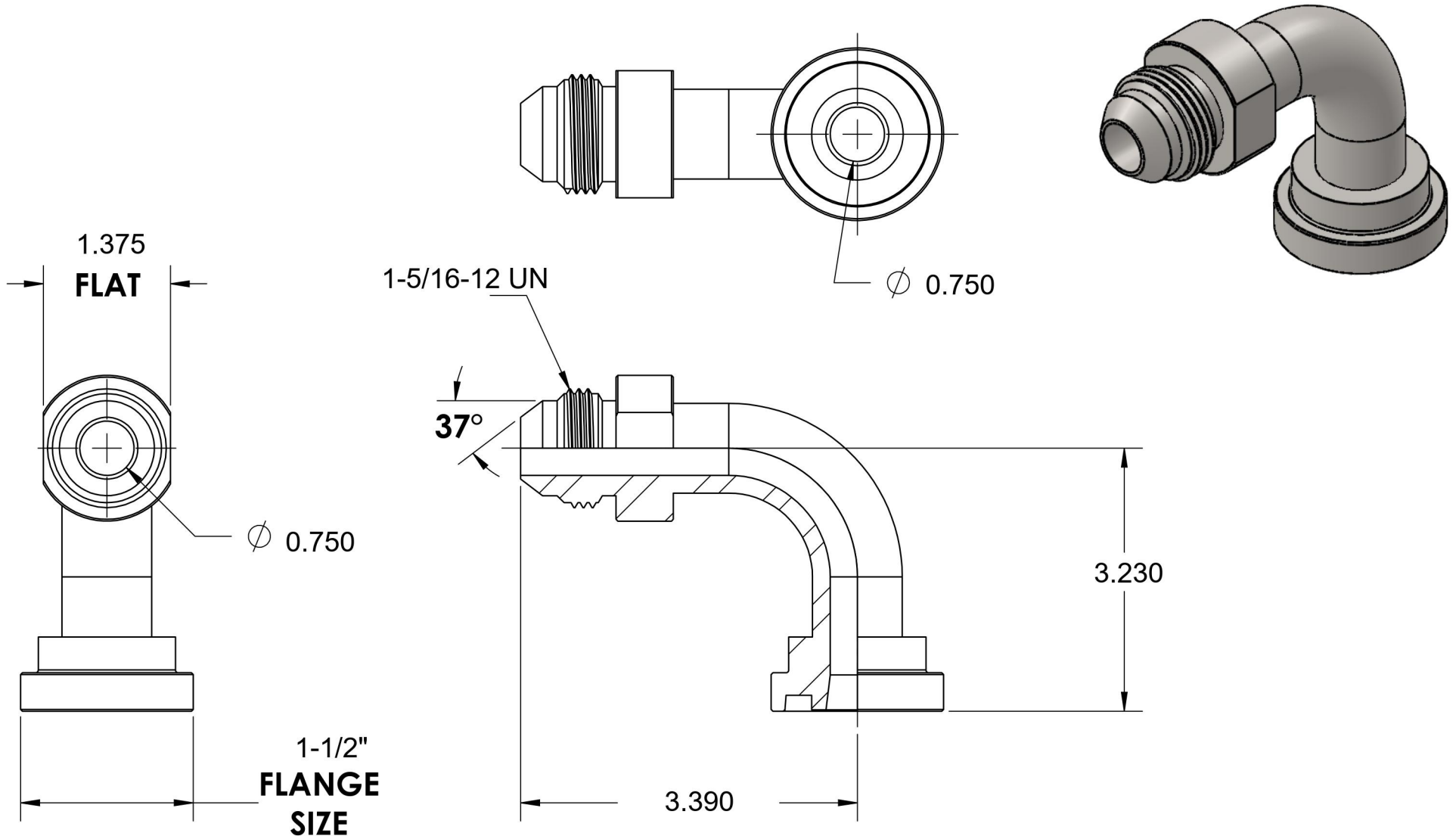

6701 Cochran Road  
Solon, Ohio 44139  
Phone: (440) 248-1880  
Toll Free: 1-888-331-1523

|                           |                          |                            |  |
|---------------------------|--------------------------|----------------------------|--|
| <b>Temperature Rating</b> | <b>Material</b>          | <b>Industry Standards</b>  | <b>Series</b>  |
| -425°F to 1200°F          | 316/316L Stainless Steel | SAE J518 Code 62, SAE J514 | 1804-SS  |
| <b>Pressure Rating</b>    | <b>Finish</b>            |                            | <b>Series Description</b>                            |
| 3000 psi                  | Passivation              |                            | SAE J514 37° Flare Code 62<br>Flange 90° Swept Elbow |