

7009-08-22

Steel, SAE J514 37° Flare Male Komatsu Adapter, 1/2" Male JIC x M22X1.5 Male Komatsu

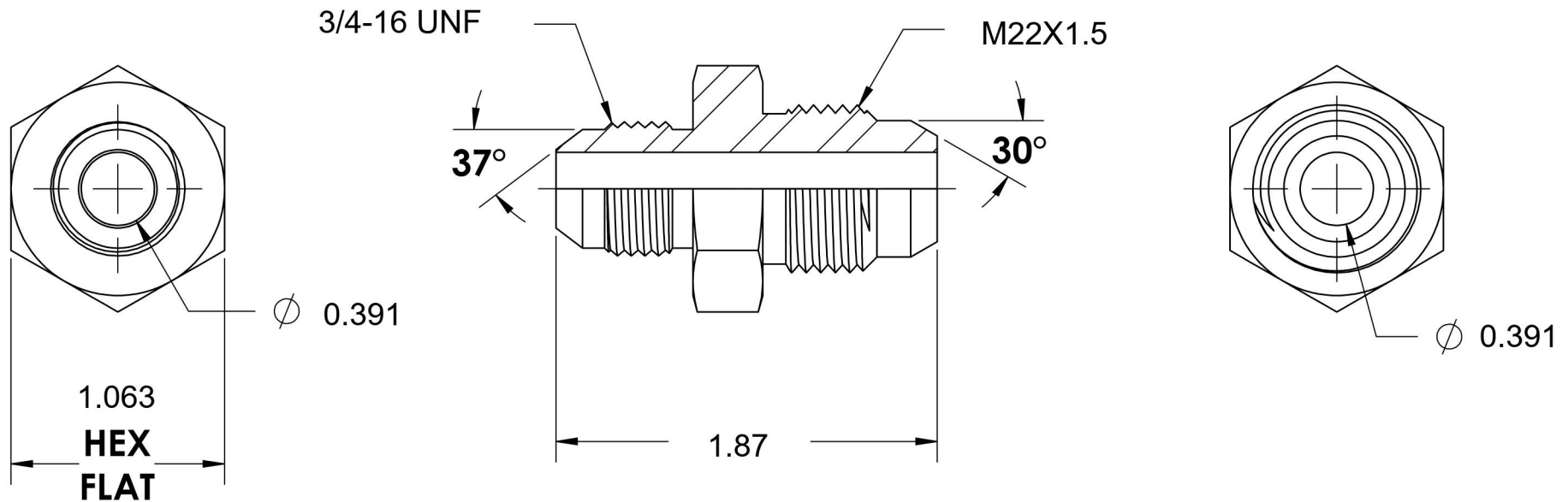
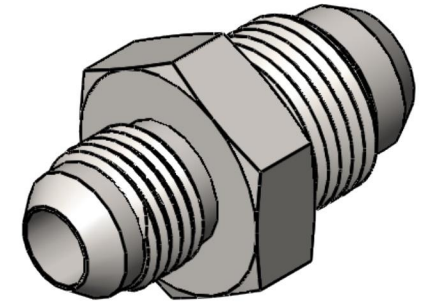

6701 Cochran Road
Solon, Ohio 44139
Phone: (440) 248-1880
Toll Free: 1-888-331-1523

Temperature Rating -65°F to 500°F	Material C1045 / 12L14 Steel	Industry Standards SAE J514, ASTM B633 Komatsu Standard	Series 7009
Pressure Rating 4000 psi	Finish Trivalent Zinc		Series Description SAE J514 37° Flare Male Komatsu Adapter