

6400-04-03-O-SS-VITON

Stainless Steel, SAE J514 37° Flare Port Connector, 1/4" Male JIC x 3/8-24 Male ORB, FKM Seal

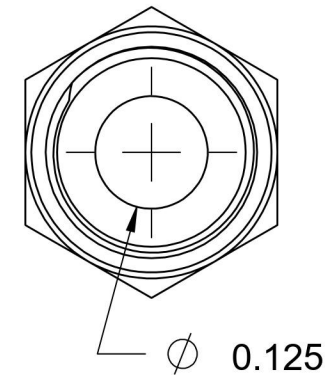
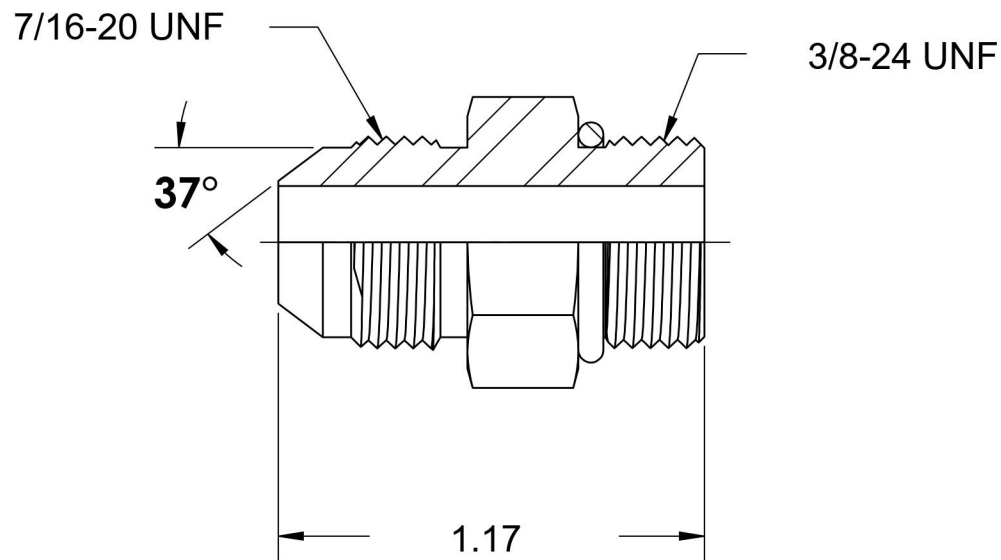
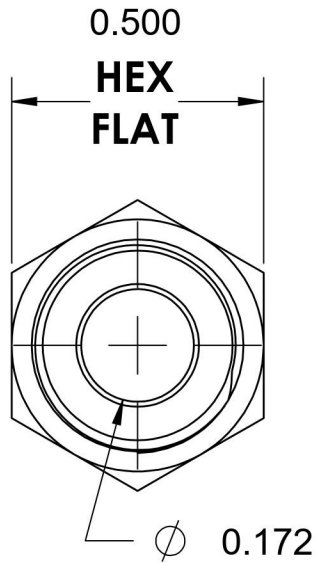
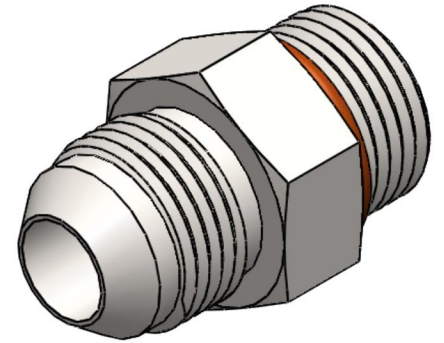

6701 Cochran Road
Solon, Ohio 44139
Phone: (440) 248-1880
Toll Free: 1-888-331-1523

Temperature Rating	Material	Industry Standards	Series
-15°F to 400°F	316/316L Stainless Steel	SAE J514, SAE J1926-3	6400-O-SS-VITON
Pressure Rating	Finish		Series Description
9000 psi	Passivated		SAE J514 37° Flare Port Connector