

FS2403-08-06-SS

Stainless Steel, SAE J1453 O-Ring Face Seal Union, 1/2" Male ORFS x 3/8" Male ORFS

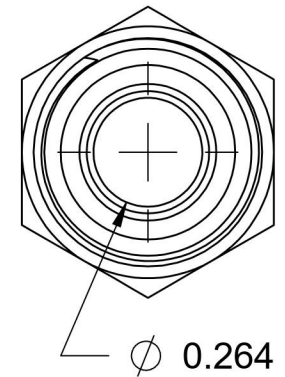
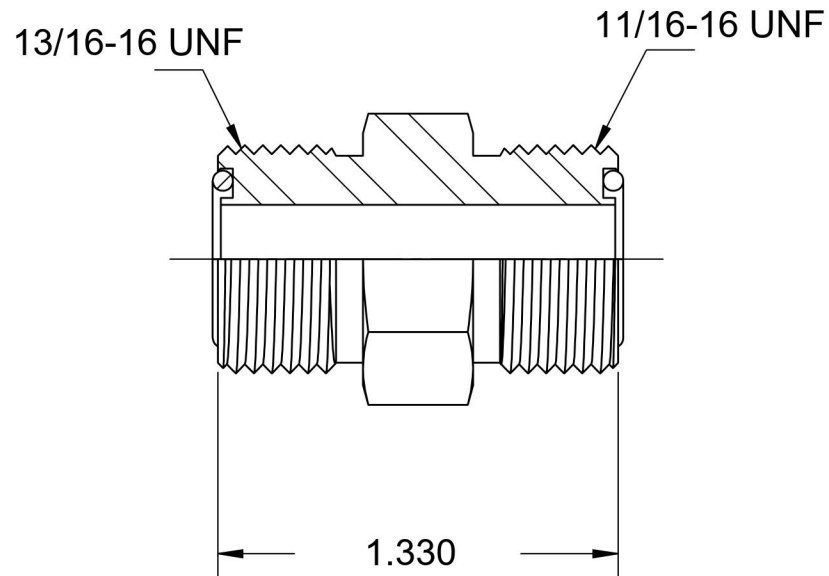
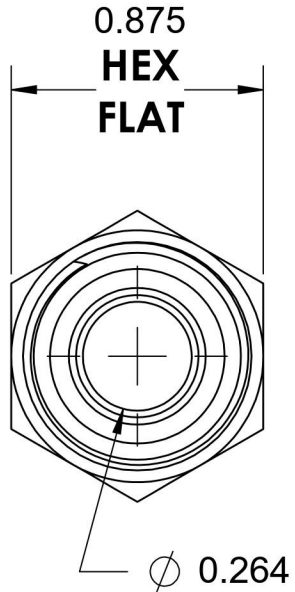
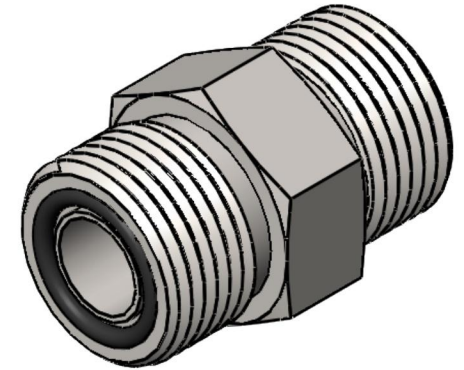

6701 Cochran Road
Solon, Ohio 44139
Phone: (440) 248-1880
Toll Free: 1-888-331-1523

Temperature Rating

-40°F to 250°F

Pressure Rating

9200 psi

Material

316/316L Stainless Steel

Finish

Passivated

Industry Standards

SAE J1453, SAE J515

Series

FS2403-SS

Series Description

SAE J1453 O-Ring Face Seal Union