

# D0319-30

Steel, DIN 2353 Double Bite Cutting Ring, 30mm Tube OD

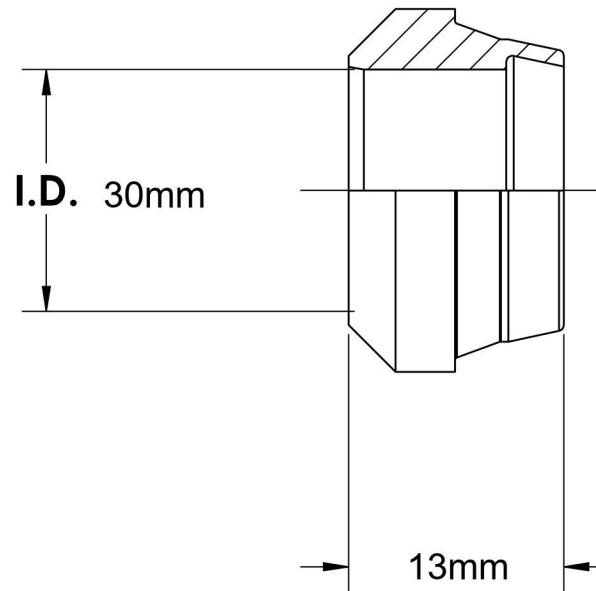
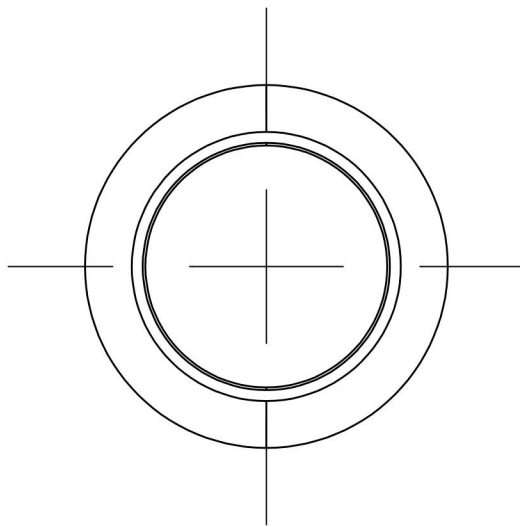
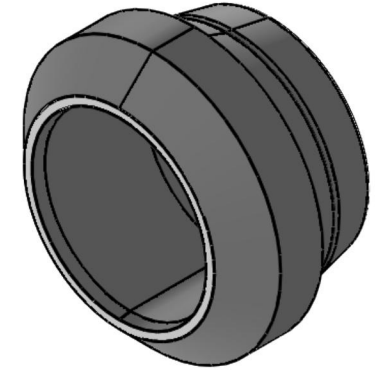

6701 Cochran Road  
Solon, Ohio 44139  
Phone: (440) 248-1880  
Toll Free: 1-888-331-1523

<b>Temperature Rating</b> -65°F to 500°F	<b>Material</b> Carbon Steel	<b>Industry Standards</b> DIN 2353, ISO 8434-1	<b>Series</b> D0319
<b>Pressure Rating</b> 6092psi	<b>Finish</b> Zinc Nickel		<b>Series Description</b> DIN 2353 Flareless Double Bite Tube Sleeve