

7005-16-S25-36-SS

Stainless Steel, SAE J514 37° Flare/ISO 8434-1 Heavy Series Male Adapter, 1" Male JIC x M36X2.0 Male DIN

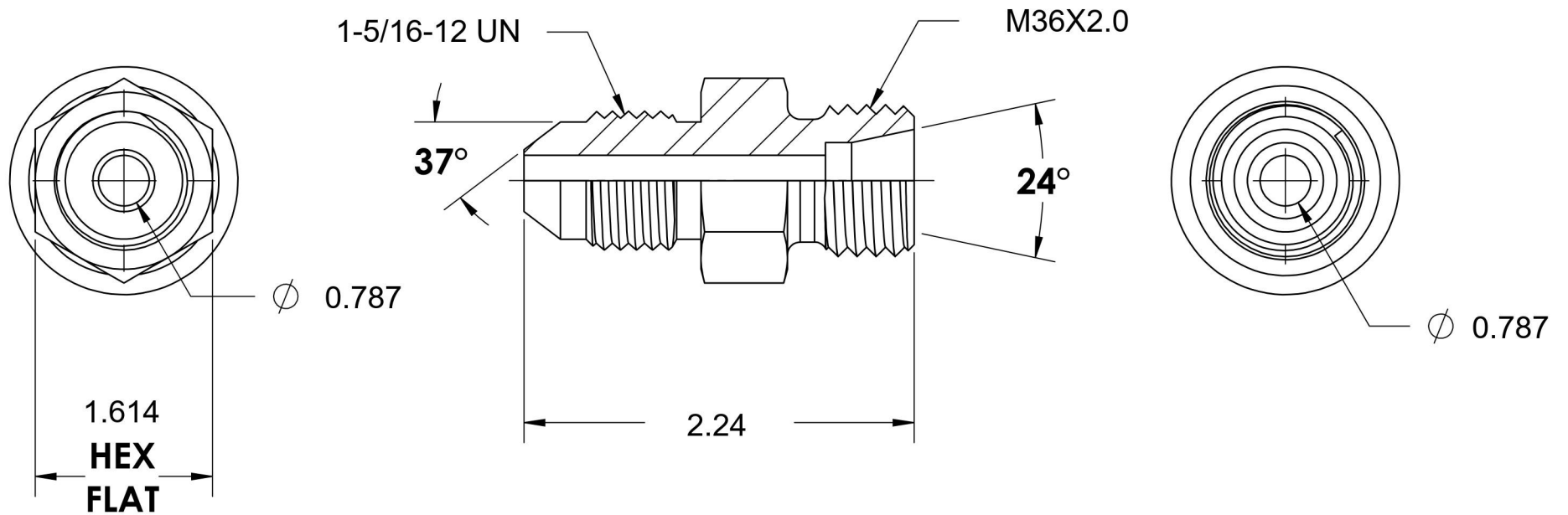

6701 Cochran Road
Solon, Ohio 44139
Phone: (440) 248-1880
Toll Free: 1-888-331-1523

Temperature Rating	Material	Industry Standards	Series
-425°F to 1200°F	316/316L Stainless Steel	SAE J514, ISO 8434-1	7005-DIN HEAVY-SS
Pressure Rating	Finish	DIN 2353	Series Description
4000 psi	Passivated		SAE J514 37° Flare/ISO 8434-1 Heavy Series Male Adapter