

7006-12-18-SS

Stainless Steel, SAE J514 37° Flare DIN Standpipe Adapter, 3/4" Male JIC x 18mm Standpipe

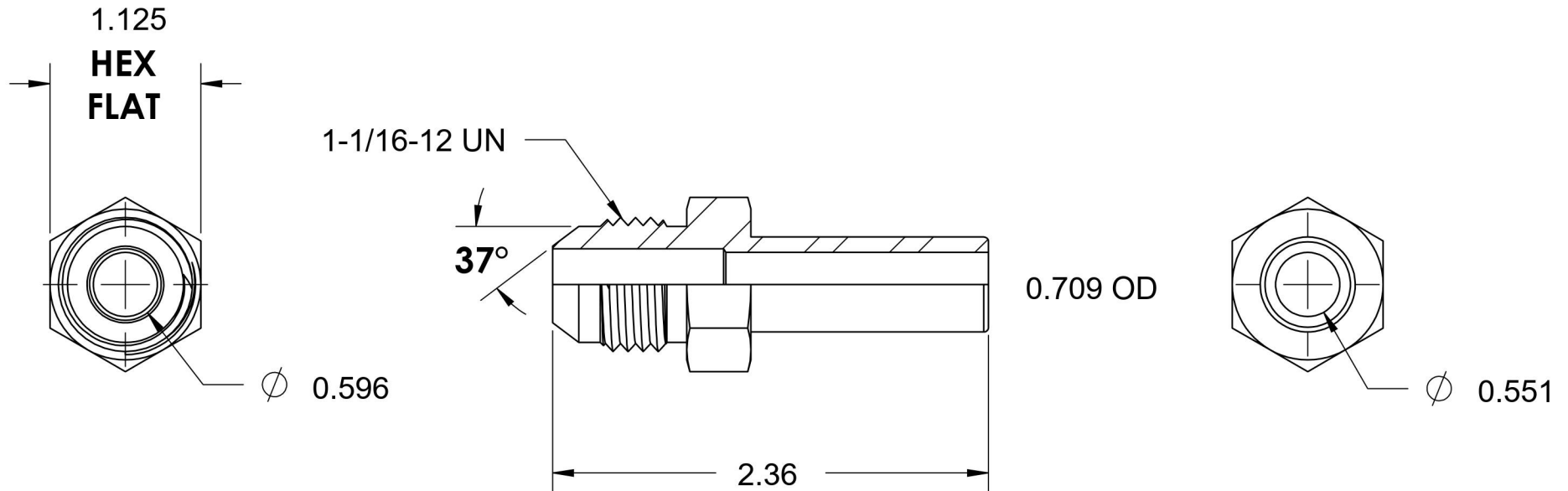

6701 Cochran Road
Solon, Ohio 44139
Phone: (440) 248-1880
Toll Free: 1-888-331-1523

Temperature Rating	Material	Industry Standards	Series
-425°F to 1200°F	316/316L Stainless Steel	SAE J514, ISO 8434-1	7006-SS
Pressure Rating	Finish	DIN 2353	Series Description
Not Available	Passivated		SAE J514 37° Flare DIN Standpipe Adapter