

6804-06-06-06-NWO-SS

Stainless Steel, SAE J514 37° Flare Adjustable Port Run Tee, 3/8" Male JIC x 9/16-18 Male Adjustable ORB x 3/8" Male JIC

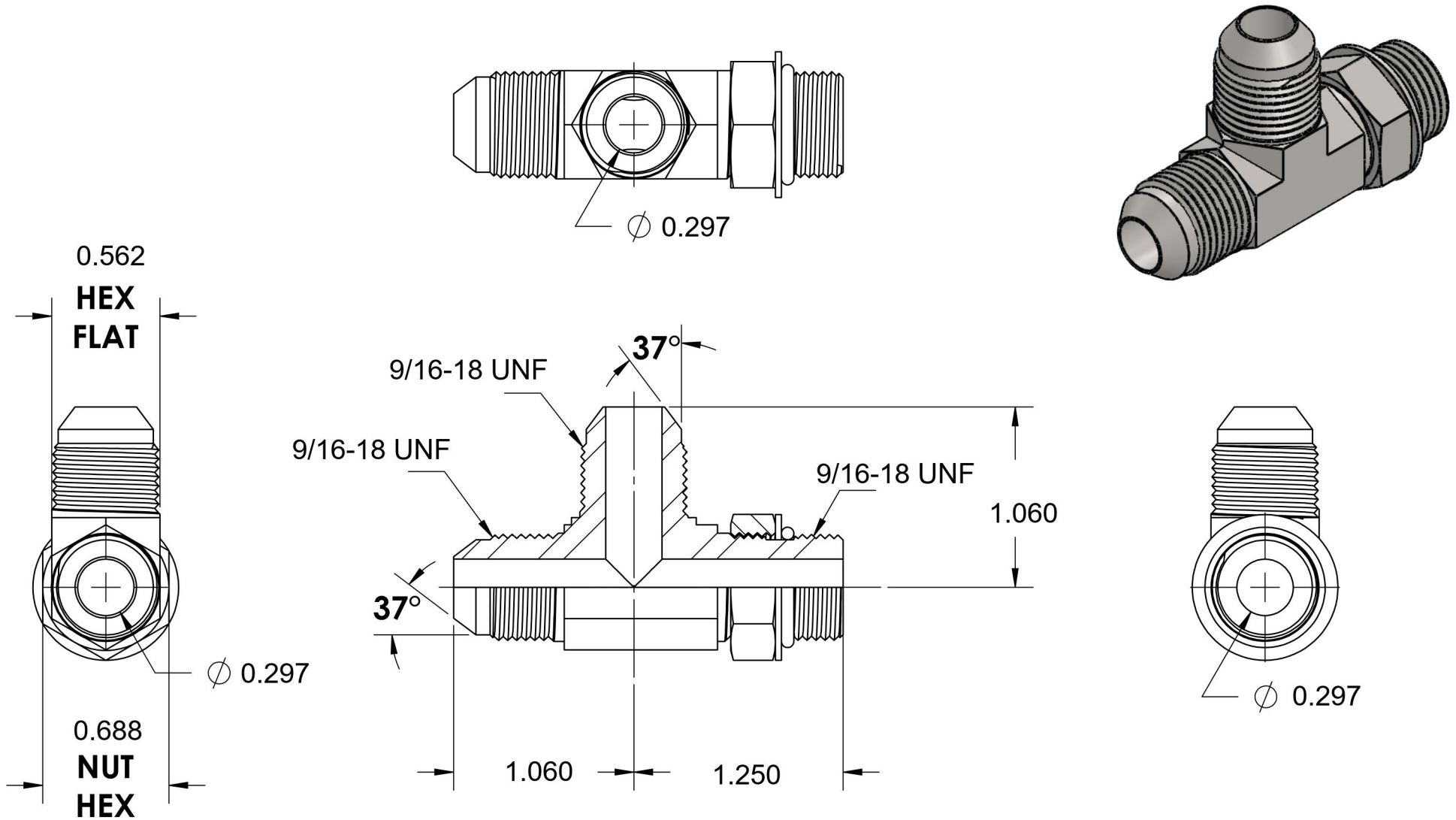

6701 Cochran Road
Solon, Ohio 44139
Phone: (440) 248-1880
Toll Free: 1-888-331-1523

Temperature Rating

-40°F to 250°F

Pressure Rating

5400 psi

Material

316/316L Stainless Steel

Finish

Passivated

Industry Standards

SAE J514, SAE J1926-3
SAE J515

Series

6804-NWO-SS

Series Description

SAE J514 37° Flare
Adjustable Port Run Tee