

6506-08-08

Steel, SAE J514 37° Flare Swivel Female Connector, 1/2" Female NPTF x 1/2" Female JIC Swivel

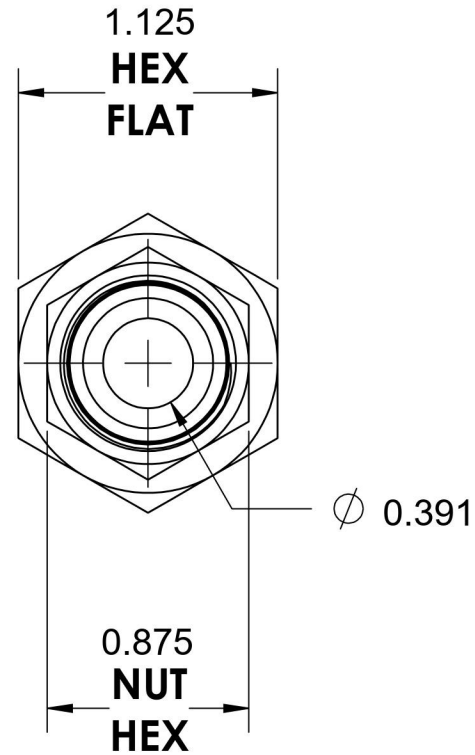
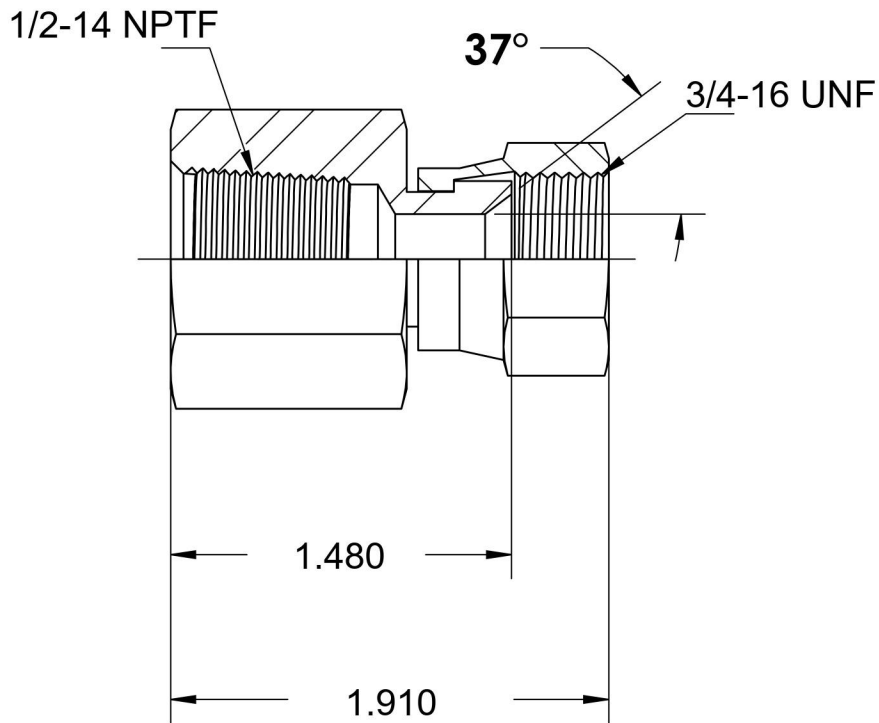

6701 Cochran Road
Solon, Ohio 44139
Phone: (440) 248-1880
Toll Free: 1-888-331-1523

Temperature Rating -65°F to 500°F	Material C1045/12L14 Steel	Industry Standards SAE J514 , SAE J476 ASTM B633	Series 6506
Pressure Rating 5000 psi	Finish Trivalent Zinc		Series Description SAE J514 37° Flare Swivel Female Connector