

2406-06-06-R.060

06FJ-06MJ Straight, Restricted .060"ID

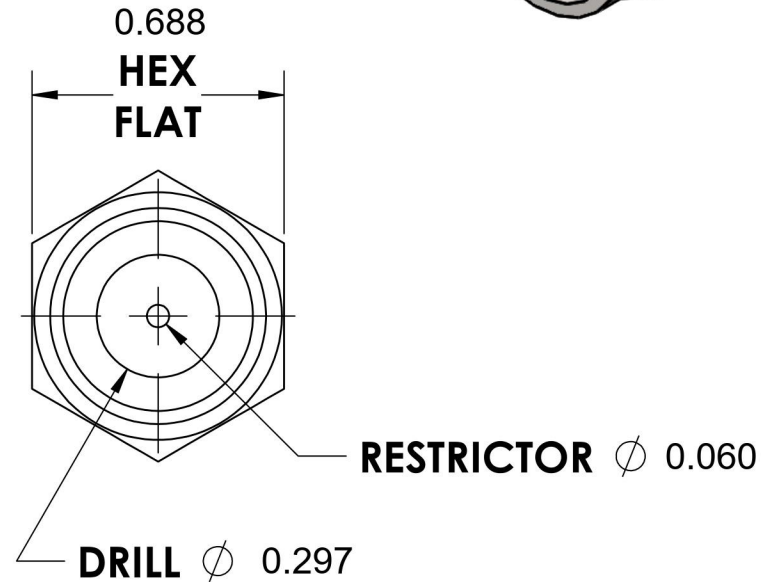
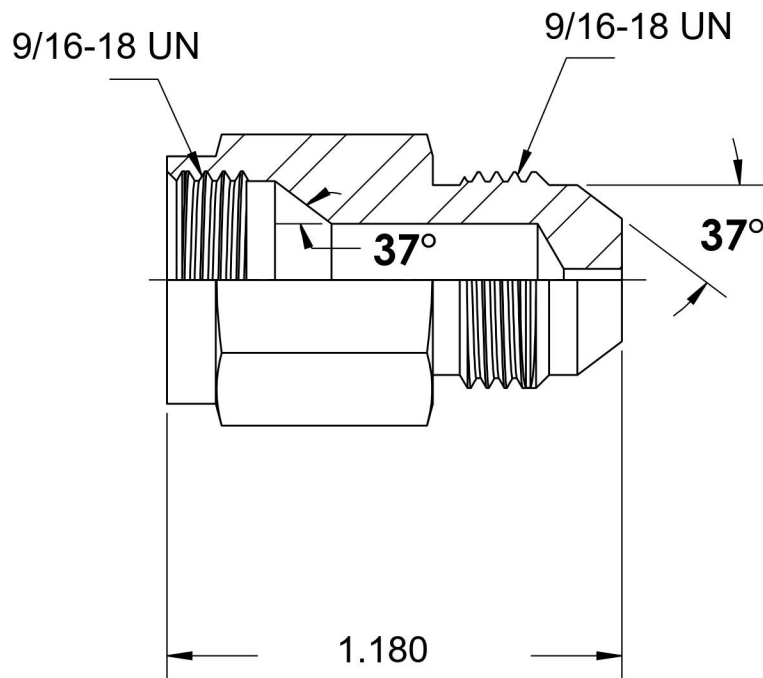
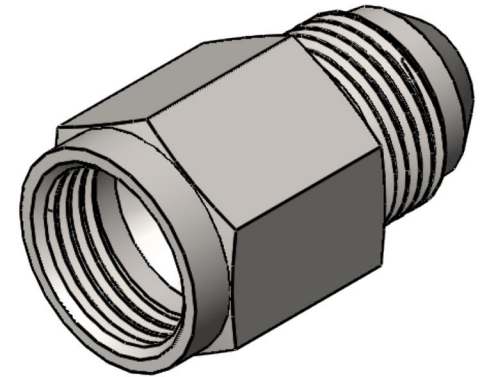

6701 Cochran Road
Solon, Ohio 44139
Phone: (440) 248-1880
Toll Free: 1-888-331-1523

Temperature Rating -65°F to 500°F	Material C1045/12L14 Steel	Industry Standards SAE J514, ASTM B633	Series 2406-RESTRICTED
Pressure Rating Not Available	Finish Trivalent Zinc		Series Description SAE J514 37° Flare Restricted Reducer