

# 1503-32-32-FG

Steel, SAE J514 NPSM Swivel 45° Male Elbow, 2" Male NPTF 30° x 2" Female NPSM Swivel

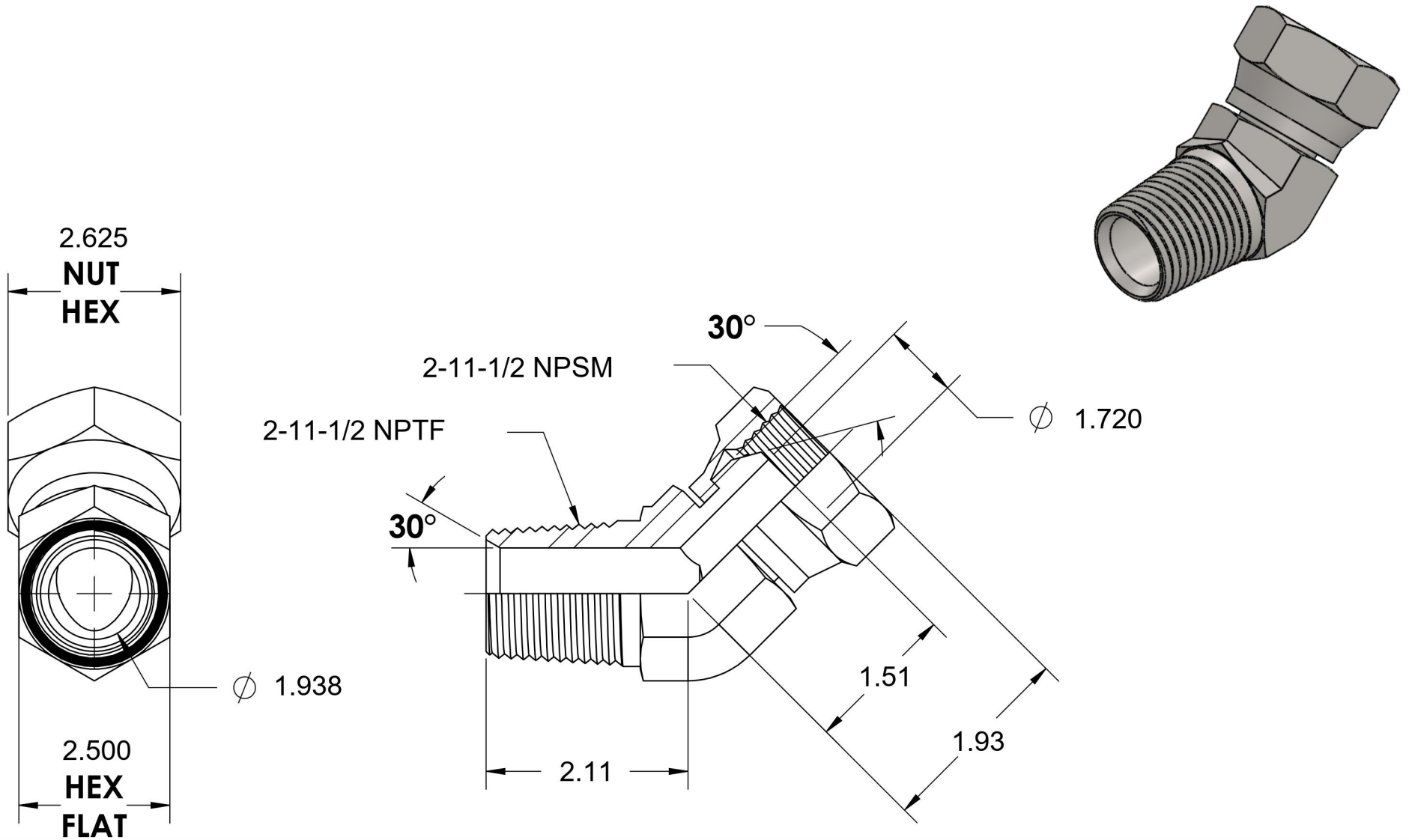

6701 Cochran Road  
Solon, Ohio 44139  
Phone: (440) 248-1880  
Toll Free: 1-888-331-1523

<b>Temperature Rating</b>	<b>Material</b>	<b>Industry Standards</b>	<b>Series</b>
-65°F to 500°F	C1045 Steel	SAE J514, SAE J476 ASTM B633	1503-FG
<b>Pressure Rating</b>	<b>Finish</b>		<b>Series Description</b>
1100 psi	Trivalent Zinc		SAE J514 NPSM Swivel 45° Male Elbow