

5502-06-06-FG-B

Brass, SAE J514 Pipe 90° Street Elbow, 3/8" Male NPTF 30° x 3/8" Female NPTF

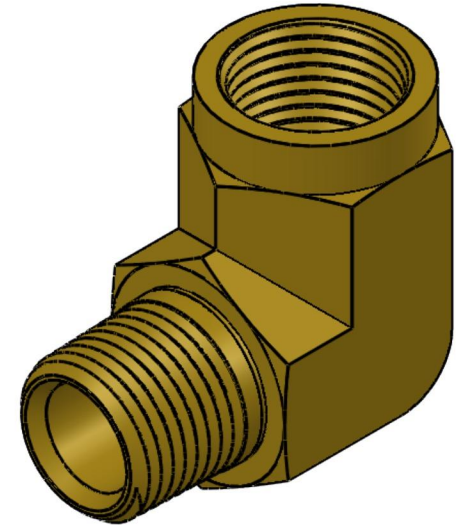
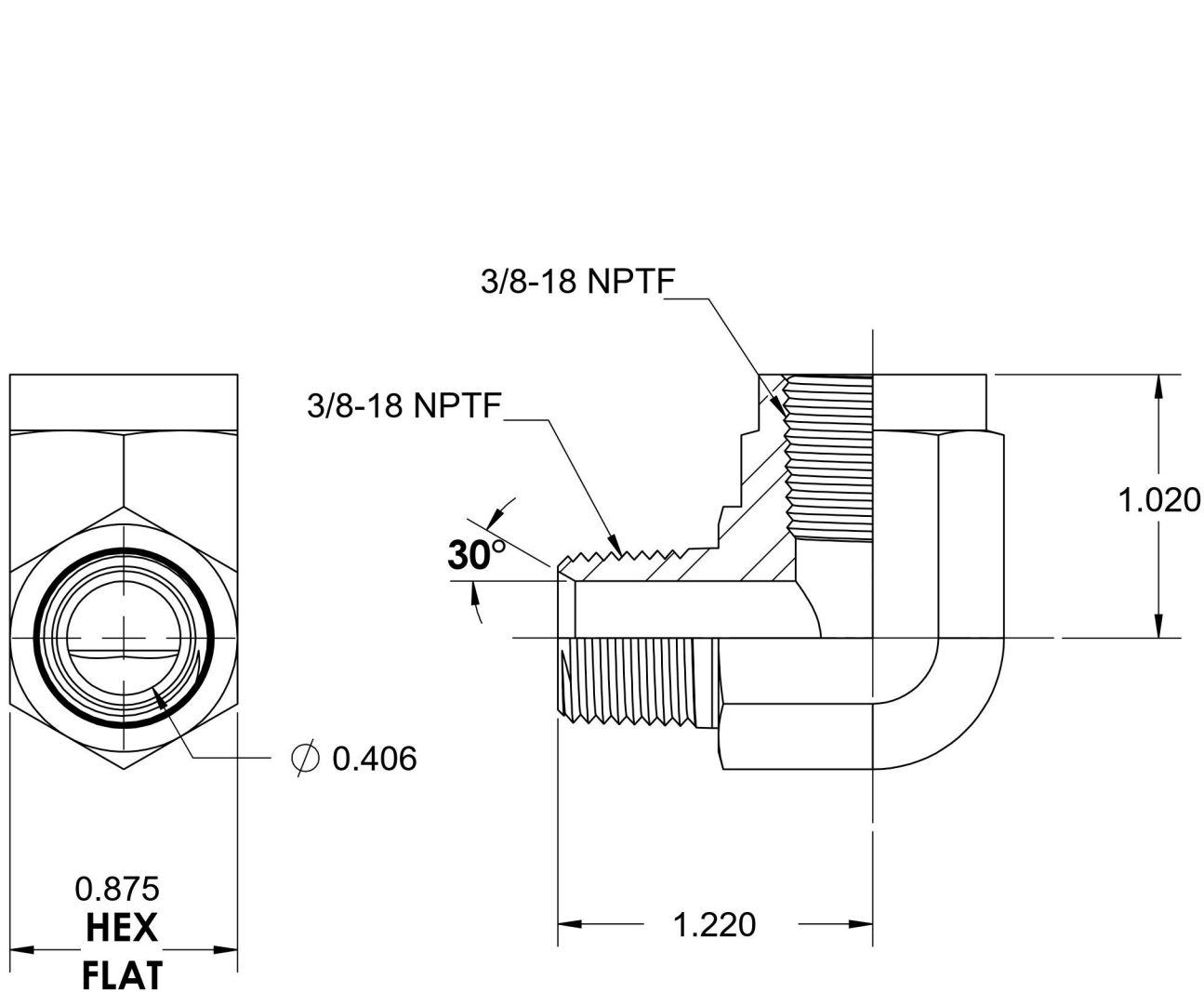

6701 Cochran Road
Solon, Ohio 44139
Phone: (440) 248-1880
Toll Free: 1-888-331-1523

Temperature Rating

-325°F to 400°F

Pressure Rating

3000 psi

Material

CA37700 Brass

Finish

Natural Finish

Industry Standards

SAE J514 , SAE J476

Series

5502-B

Series Description

SAE J514 Pipe 90° Street Elbow