

# 6804-12-08-12-NWO-FG

Steel, SAE J514 37° Flare Adjustable Port Run Tee, 3/4" Male JIC x 3/4-16 Male Adjustable ORB x 3/4" Male JIC

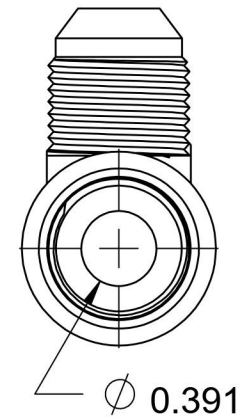
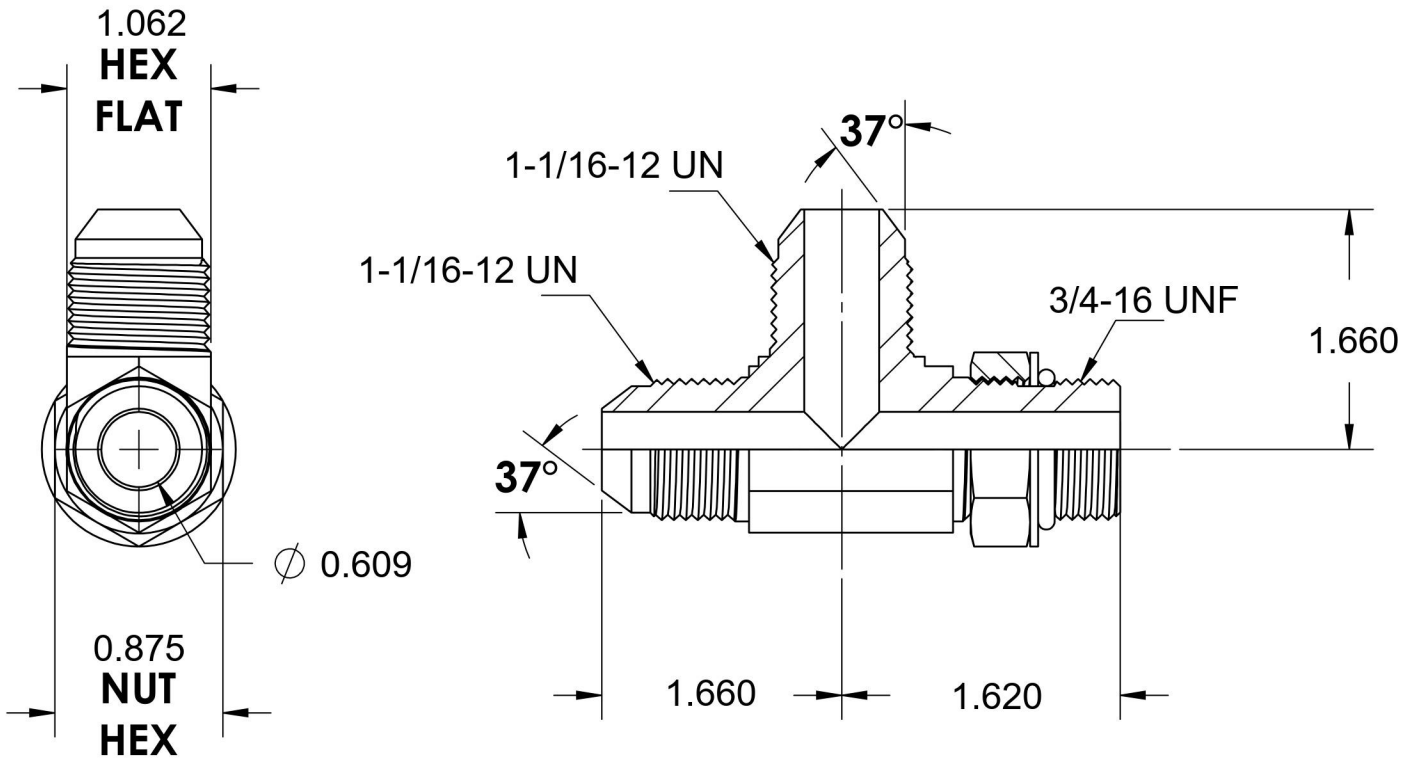
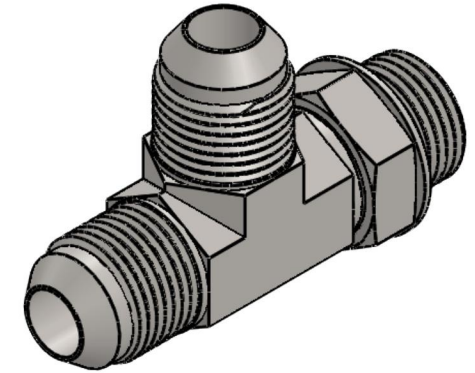
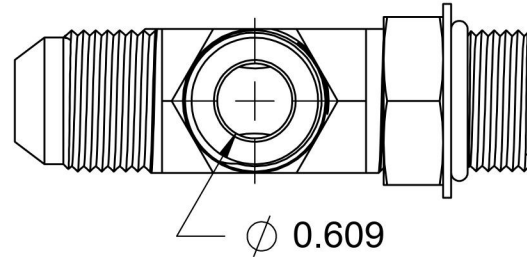

6701 Cochran Road  
Solon, Ohio 44139  
Phone: (440) 248-1880  
Toll Free: 1-888-331-1523

**Temperature Rating**

-40°F to 250°F

**Pressure Rating**

5000 psi

**Material**

C1045 Steel

**Finish**

Trivalent Zinc

**Industry Standards**

SAE J514, SAE J1926-3  
SAE J515, ASTM B633

**Series**

6804-NWO-FG

**Series Description**

SAE J514 37° Flare  
Adjustable Port Run Tee