

7640-12-22-O

Steel, SAE J514 37° Flare Male Metric (ISO 6149) Port Connector, 3/4" Male JIC x M22X1.5 Male Metric ORB

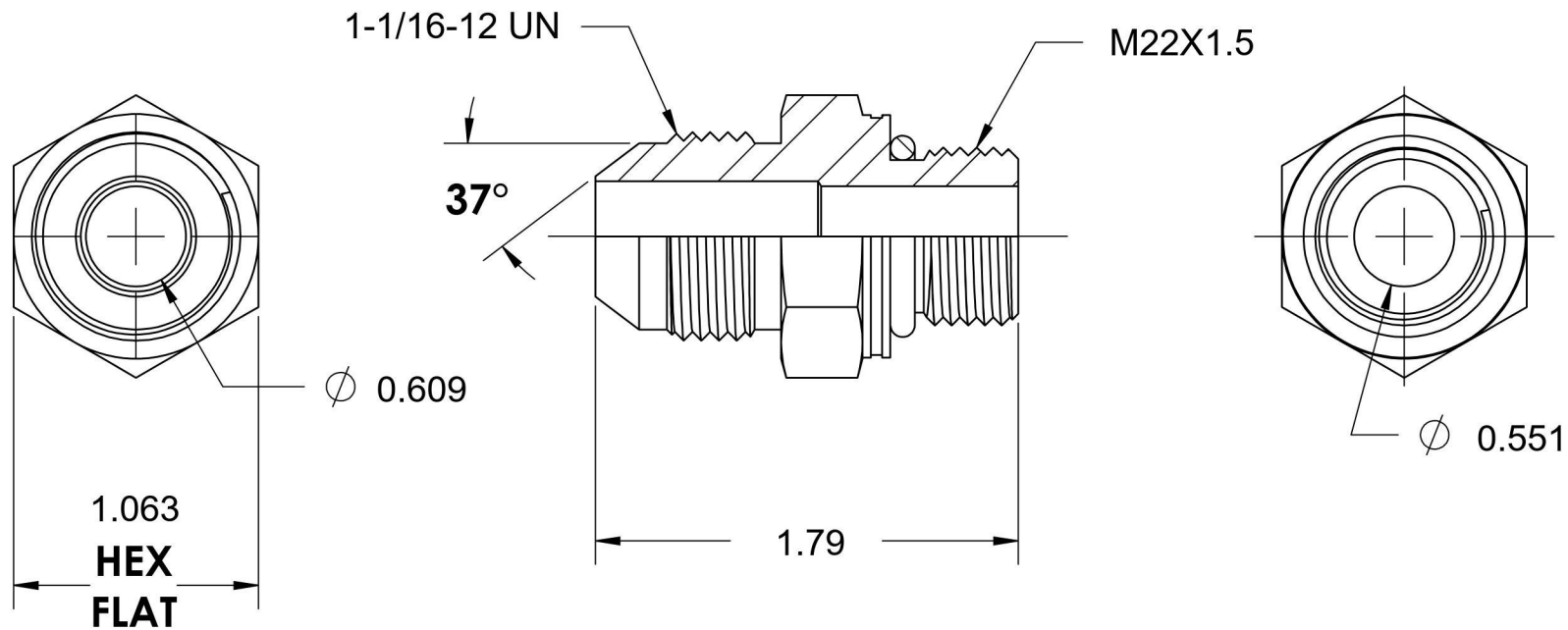
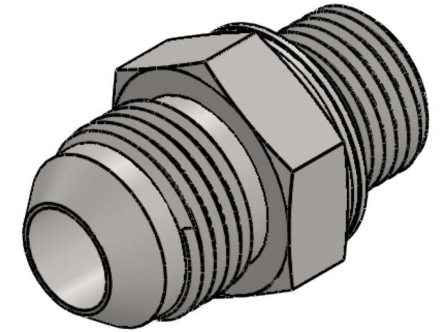

6701 Cochran Road
Solon, Ohio 44139
Phone: (440) 248-1880
Toll Free: 1-888-331-1523

Temperature Rating	Material	Industry Standards	Series
-40°F to 250°F	C1045 / 12L14 Steel	SAE J514, ISO 6149	7640-O-ISO 6149
Pressure Rating	Finish	ASTM B633	Series Description
5000 psi	Trivalent Zinc		SAE J514 37° Flare Male Metric (ISO 6149) Port Connector