

# 6400-12-12-O-VITON

Steel, SAE J514 37° Flare Port Connector, 3/4" Male JIC x 1-1/16-12 Male ORB, FKM Seal

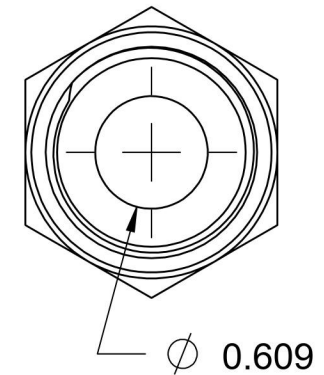
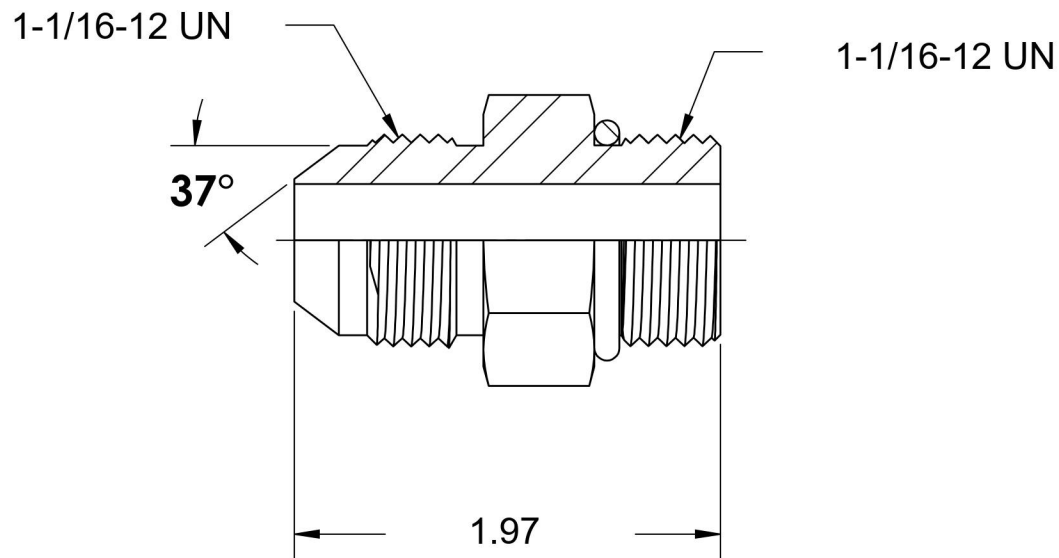
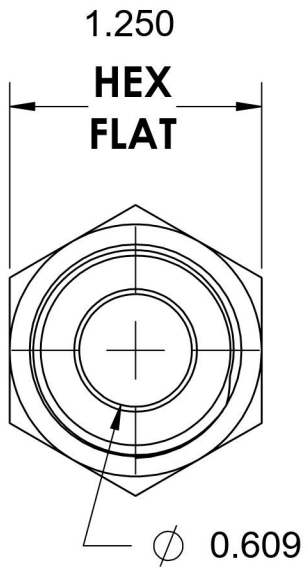
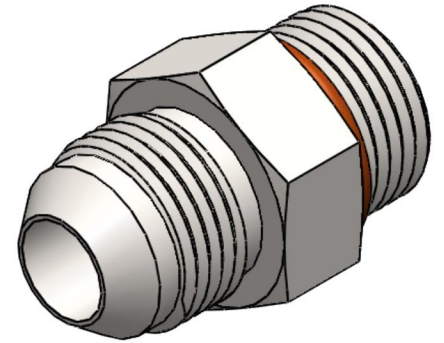

6701 Cochran Road  
Solon, Ohio 44139  
Phone: (440) 248-1880  
Toll Free: 1-888-331-1523

**Temperature Rating**

-15°F to 400°F

**Pressure Rating**

5000 psi

**Material**

C1045 / 12L14 Steel

**Finish**

Trivalent Zinc

**Industry Standards**

SAE J514, SAE J1926-3

ASTM B633

**Series**

6400-O-VITON

**Series Description**

SAE J514 37° Flare Port Connector