

2501-L-06-02-SS

Stainless Steel, SAE J514 37° Flare 90° Long Male Elbow, 3/8" Male JIC x 1/8" Male NPTF 30°

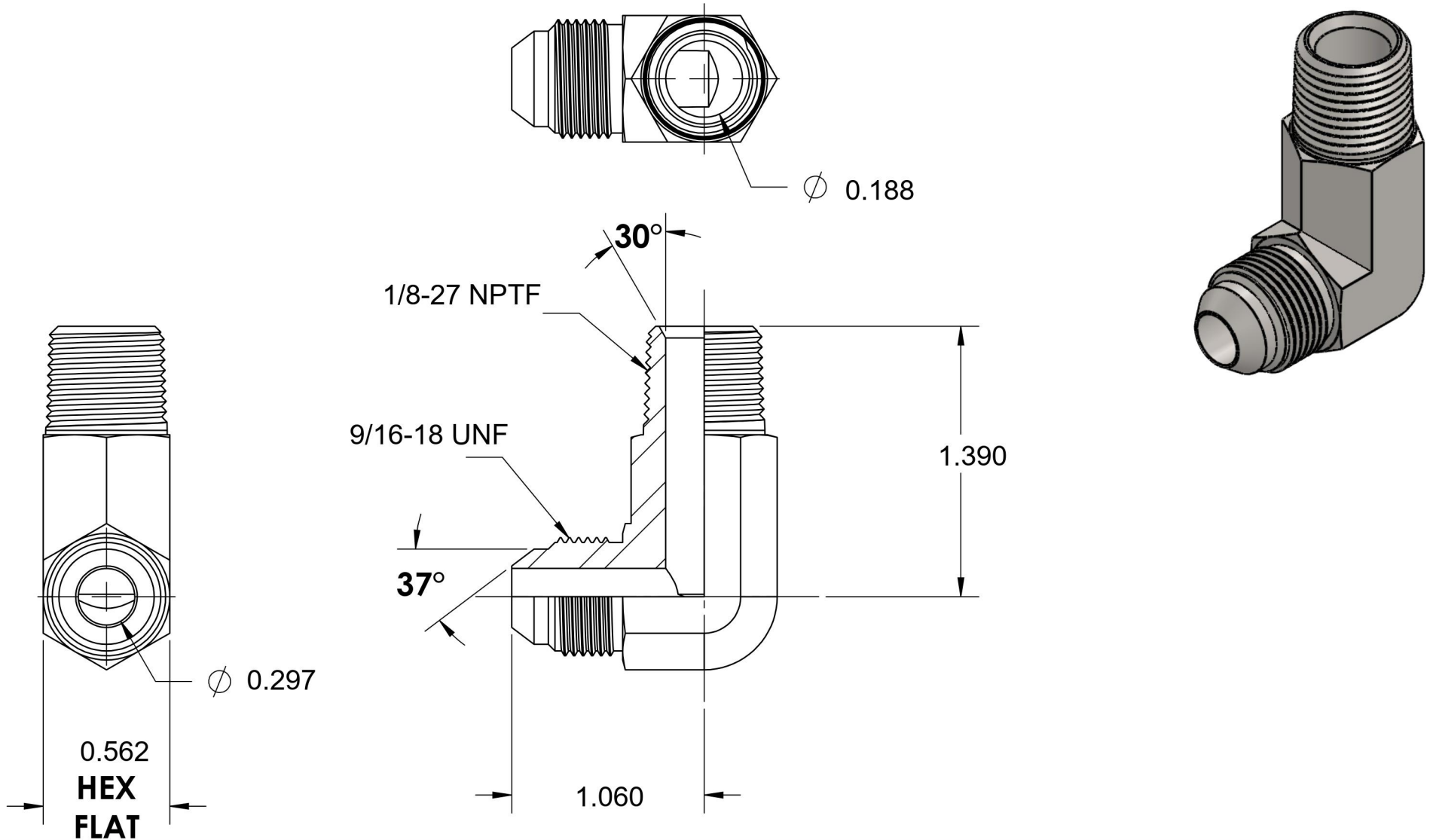

6701 Cochran Road
Solon, Ohio 44139
Phone: (440) 248-1880
Toll Free: 1-888-331-1523

Temperature Rating -425°F to 1200°F	Material 316/316L Stainless	Industry Standards SAE J514 , SAE J476	Series 2501-L-FG
Pressure Rating 6000psi	Finish Passivation		Series Description SAE J514 37° Flare 90° Long Male Elbow