

2703-LN-06-06-06-FG

Steel, SAE J514 37° Flare Bulkhead Branch Tee With Lock Nut, 3/8" Male JIC

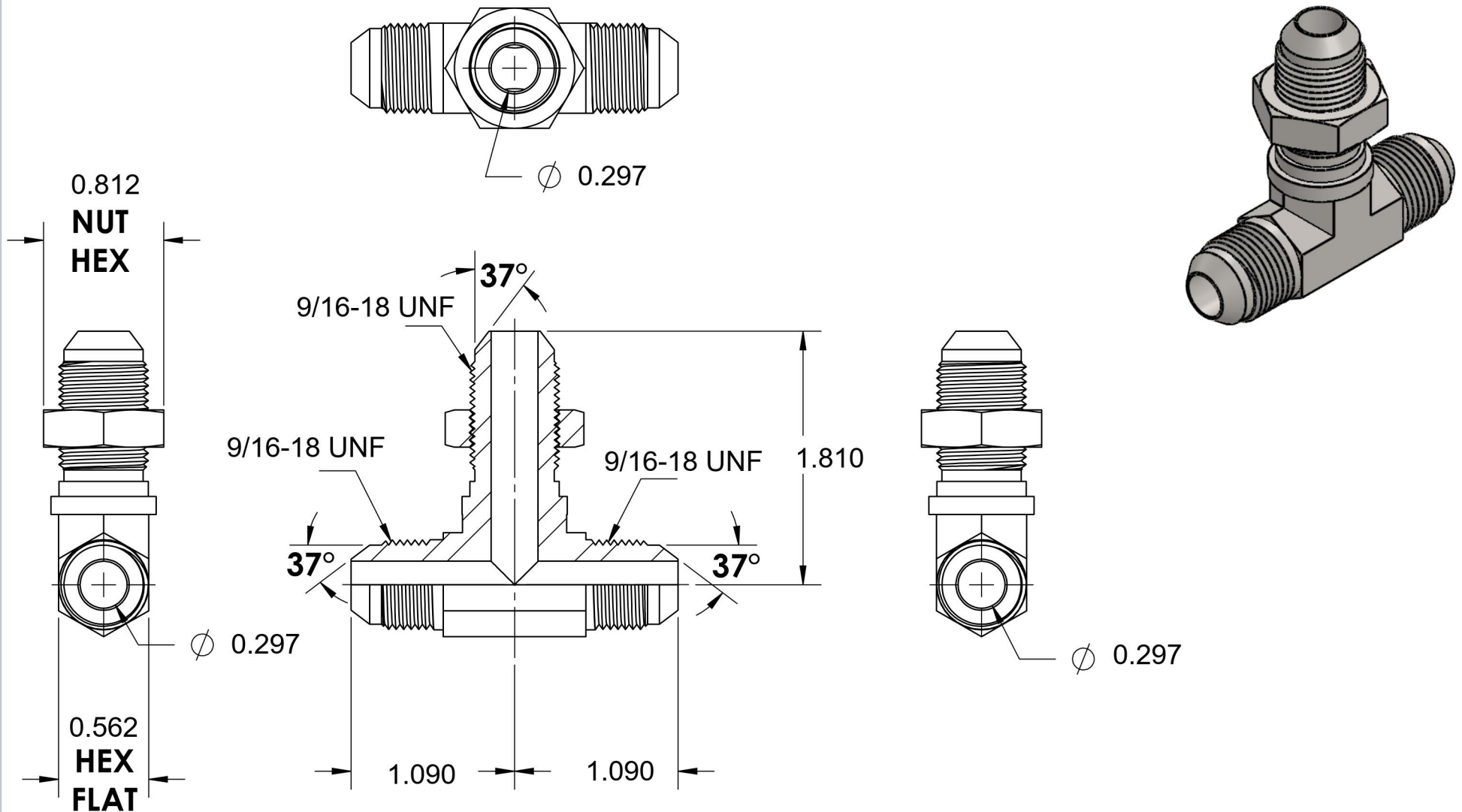

6701 Cochran Road
Solon, Ohio 44139
Phone: (440) 248-1880
Toll Free: 1-888-331-1523

Temperature Rating	Material	Industry Standards	Series
-65°F to 500°F	C1045 Steel	SAE J514, ASTM B633	2703-LN-FG
Pressure Rating	Finish		Series Description
6000psi	Trivalent Zinc		SAE J514 37° Flare Bulkhead Branch Tee With Lock Nut