

6802-12-12-NWO-FG-VITON

Steel, SAE J514 37° Flare 45° Adjustable Port Elbow, 3/4" Male JIC x 1-1/16-12 Male Adjustable ORB, FKM Seal

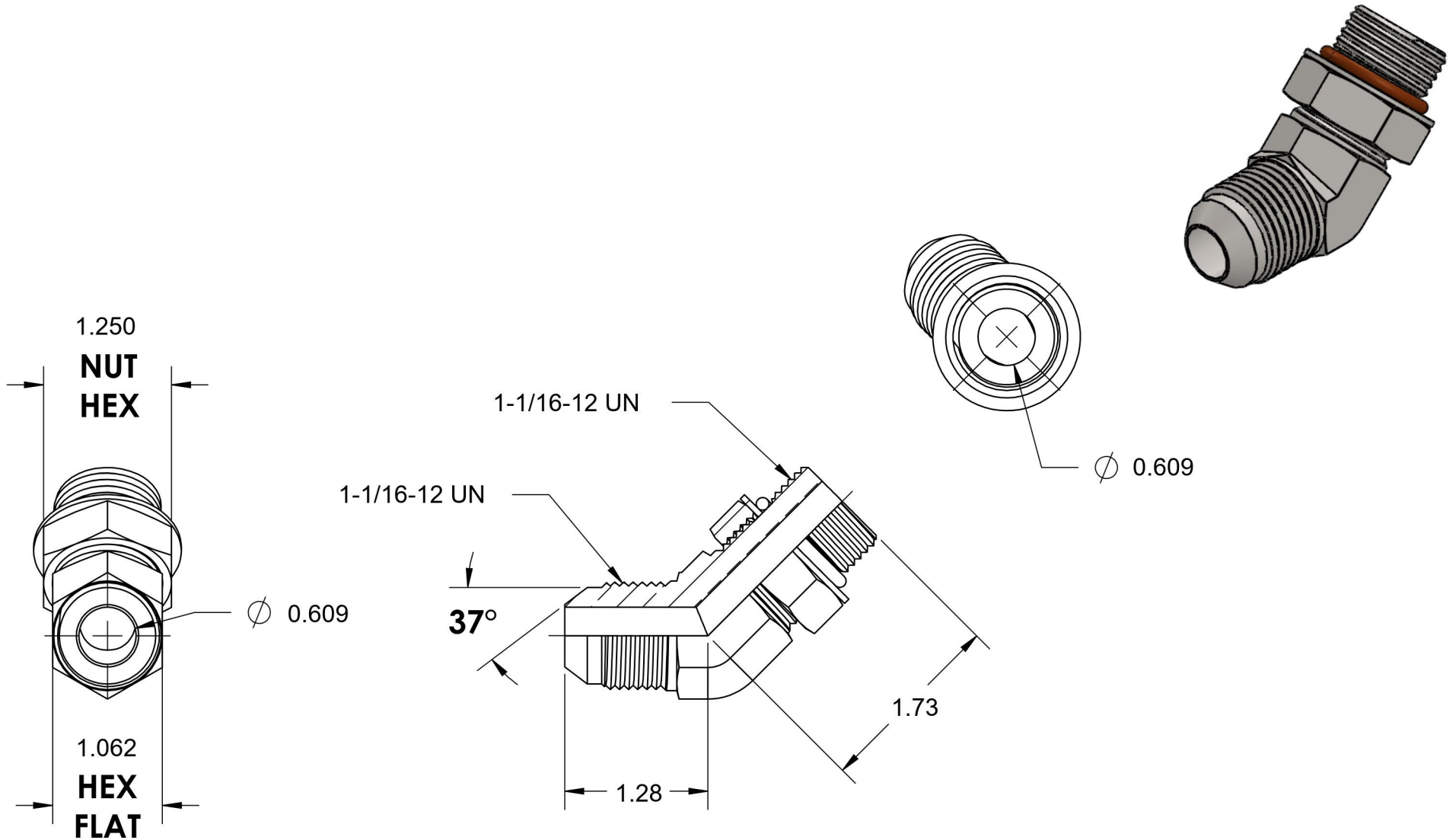

6701 Cochran Road
Solon, Ohio 44139
Phone: (440) 248-1880
Toll Free: 1-888-331-1523

Temperature Rating	Material	Industry Standards	Series
-15°F to 400°F	C1045 Steel	SAE J514, SAE J1926-3	6802-NWO-FG-VITON
Pressure Rating	Finish	SAE J515, ASTM B633	Series Description
5000 psi	Trivalent Zinc		SAE J514 37° Flare 45° Adjustable Port Elbow