

7032-06-06

Steel, SAE J476 Pipe Male BSPP Port/Line Adapter, 3/8" Male NPTF 30° x 3/8-19 Male BSPP 60° Line/Port

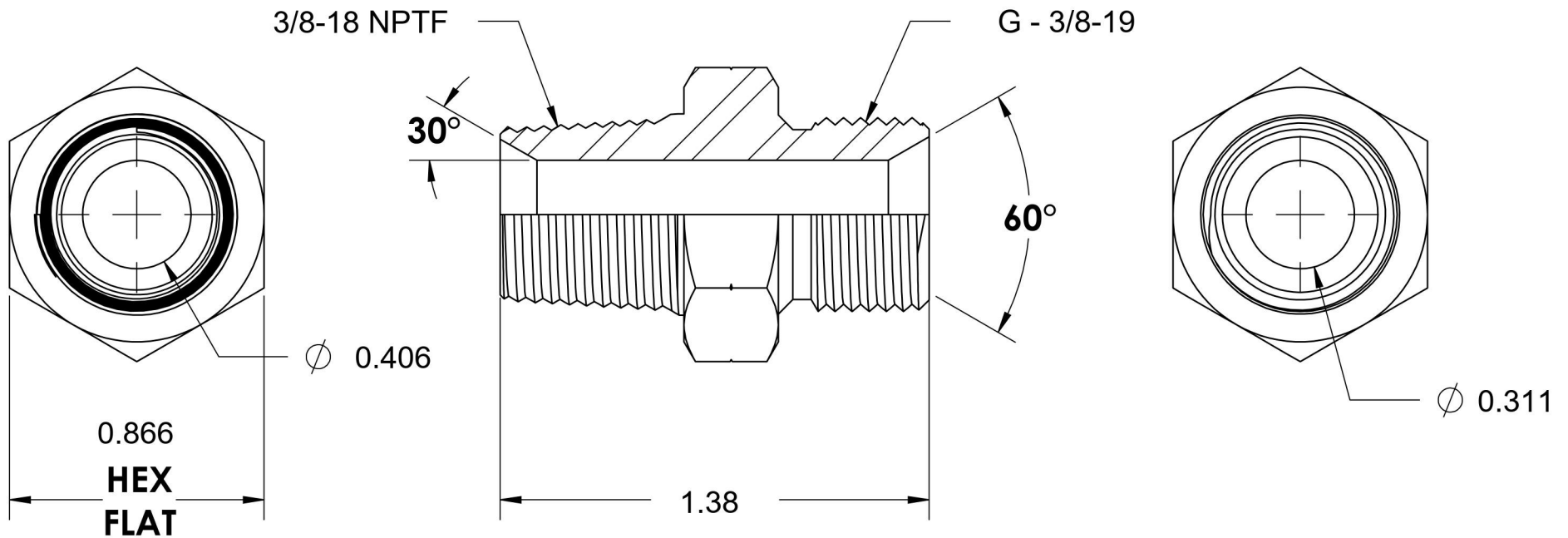

6701 Cochran Road
Solon, Ohio 44139
Phone: (440) 248-1880
Toll Free: 1-888-331-1523

Temperature Rating	Material	Industry Standards	Series
-65°F to 500°F	C1045 / 12L14 Steel	SAE J476, ISO 1179	7032
Pressure Rating	Finish	ISO 8434-6, ASTM B633	Series Description
5100 psi	Trivalent Zinc		SAE J476 Pipe Male BSPP Port/Line Adapter