

1700-16-16

Steel, SAE J514 37° Flare Code 61 Flange Adapter, 1" Male JIC x 1" Split Flange Head

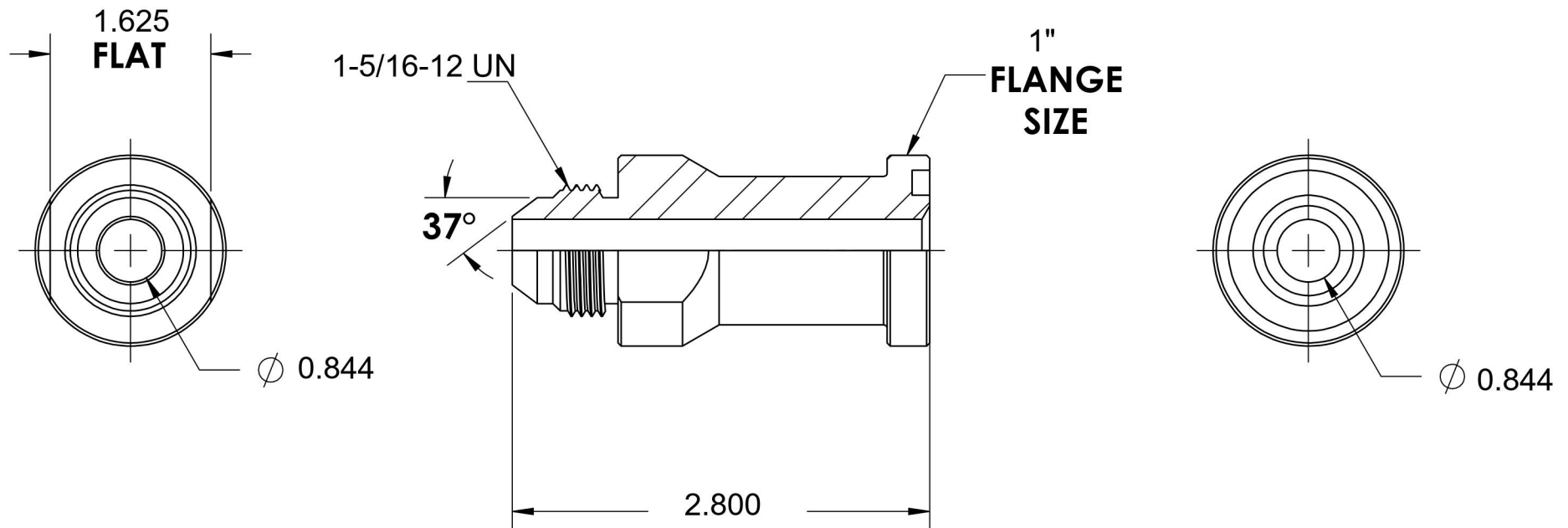
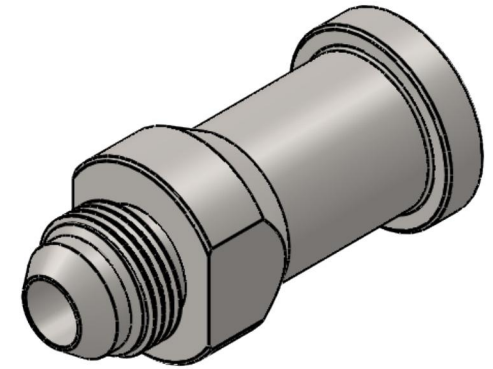

6701 Cochran Road
Solon, Ohio 44139
Phone: (440) 248-1880
Toll Free: 1-888-331-1523

Temperature Rating

-65°F to 500°F

Pressure Rating

5000 psi

Material

12L14/C1045 Steel

Finish

Trivalent Zinc

Industry Standards

SAE J518 Code 61
SAE J514, ASTM B633

Series

1700

Series Description

SAE J514 37° Flare Code 61
Flange Adapter