

2700-LN-03-03-SS

Stainless Steel, SAE J514 37° Flare Bulkhead With Lock Nut, 3/16" Male JIC x 3/16" Male JIC

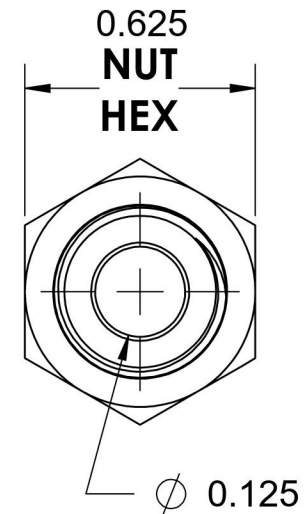
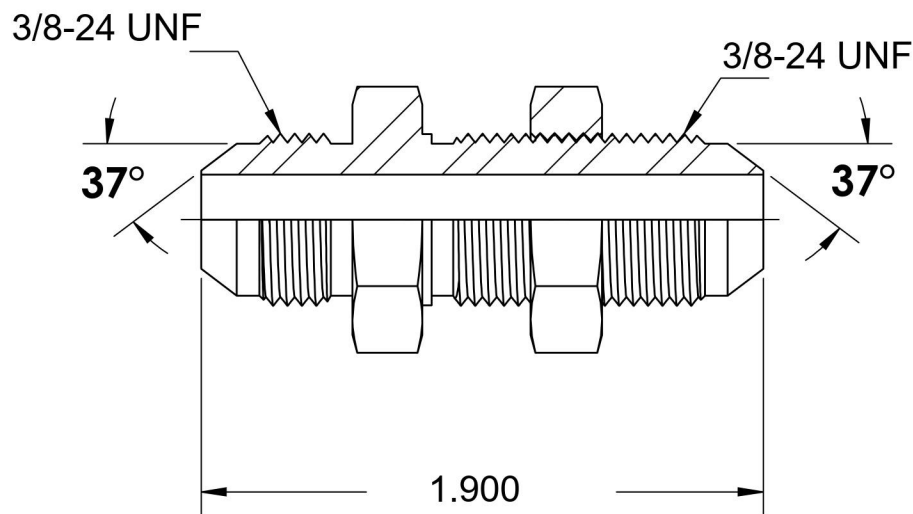
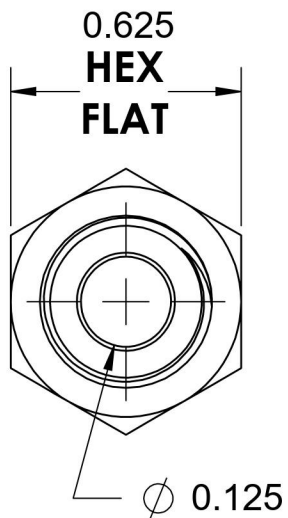
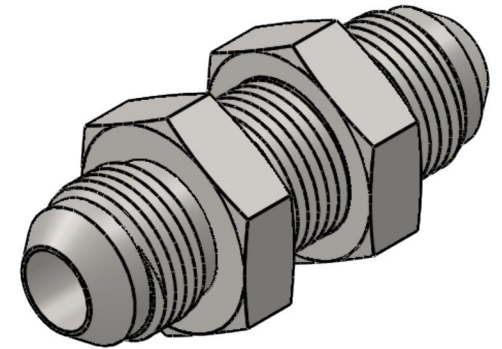

6701 Cochran Road
Solon, Ohio 44139
Phone: (440) 248-1880
Toll Free: 1-888-331-1523

Temperature Rating -425°F to 1200°F	Material 316/316L Stainless Steel	Industry Standards SAE J514	Series 2700-LN-SS
Pressure Rating 9000 psi	Finish Passivated		Series Description SAE J514 37° Flare Bulkhead With Lock Nut