

C2403-14-14

Steel, SAE J514 Flareless Tube Union, 7/8" Flareless Bite Type x 7/8" Flareless Bite Type

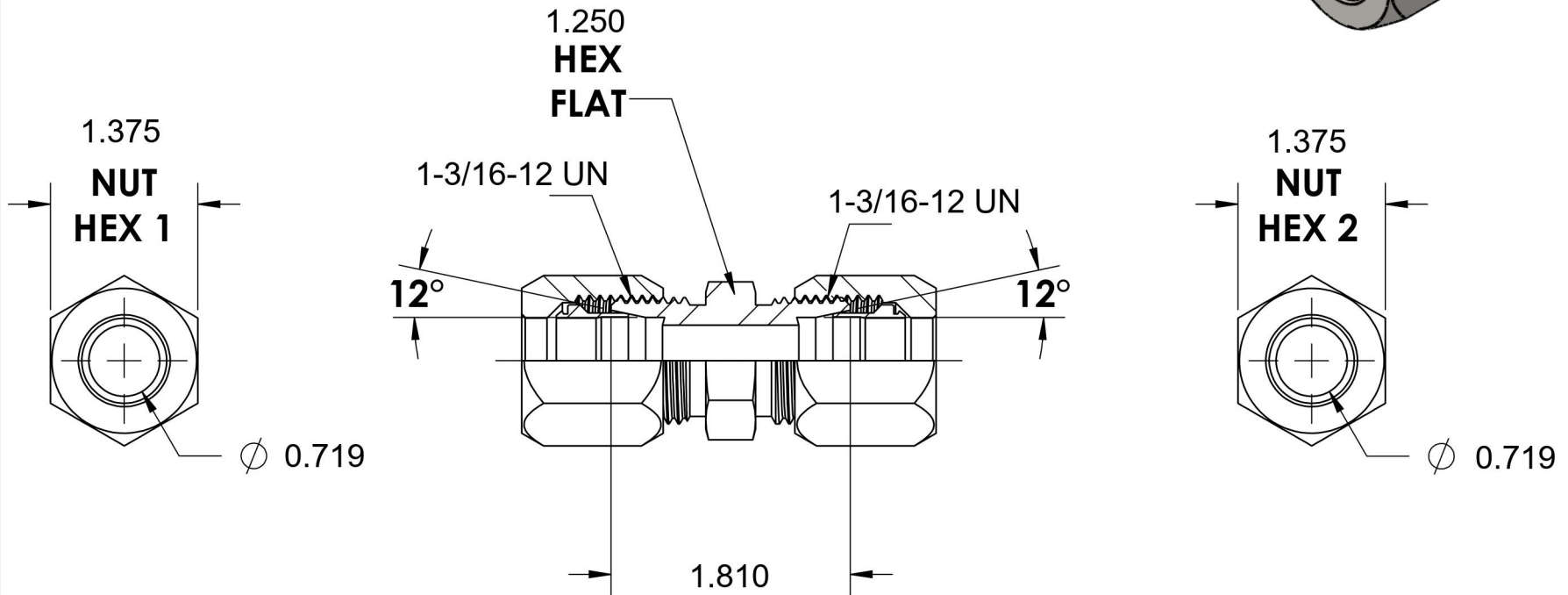

6701 Cochran Road
Solon, Ohio 44139
Phone: (440) 248-1880
Toll Free: 1-888-331-1523

Temperature Rating	Material	Industry Standards	Series
-65°F to 500°F	C1045/12L14 Steel	SAE J514, ASTM B633	C2403
Pressure Rating	Finish		Series Description
4000 psi	Trivalent Zinc		SAE J514 Flareless Tube Union