

1724-48

48 O-Ring Face Flange Plug Code 61

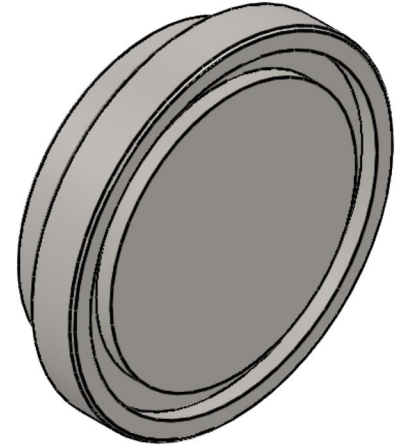
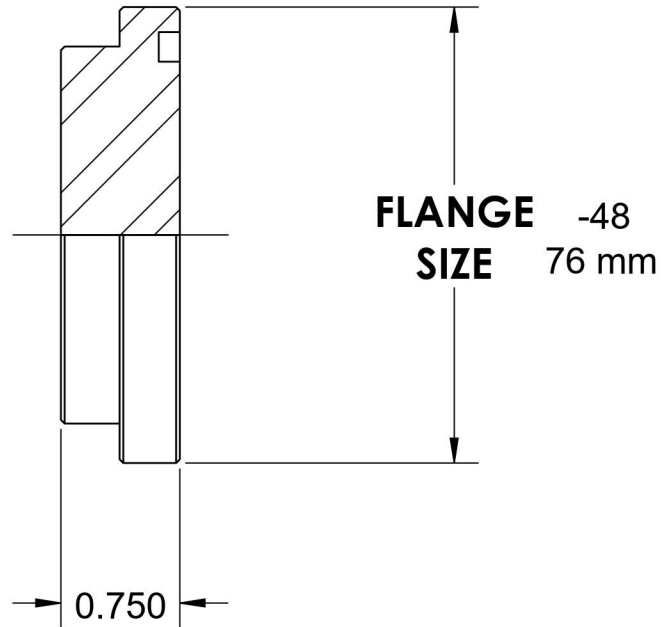
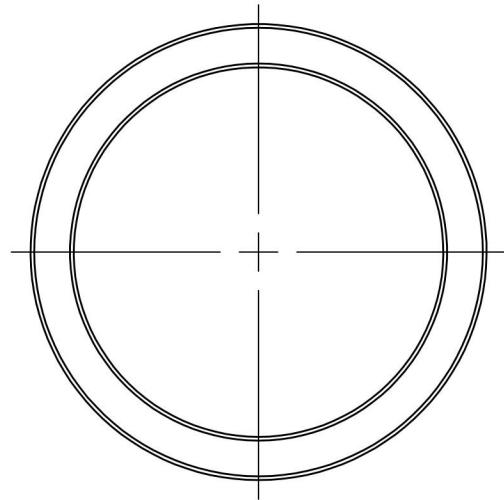

6701 Cochran Road
Solon, Ohio 44139
Phone: (440) 248-1880
Toll Free: 1-888-331-1523

Temperature Rating

-65°F to 500°F

Pressure Rating

2000 psi

Material

C1045/12L14 Steel

Finish

Trivalent Zinc

Industry Standards

SAE J518 Code 61
ASTM B633

Series

1724

Series Description

SAE J518 Code 61
Split Flange Plug