

1501-16-16-SS

Stainless Steel, SAE J514 NPSM Swivel 90° Male Elbow, 1" Male NPTF 30° x 1" Female NPSM Swivel

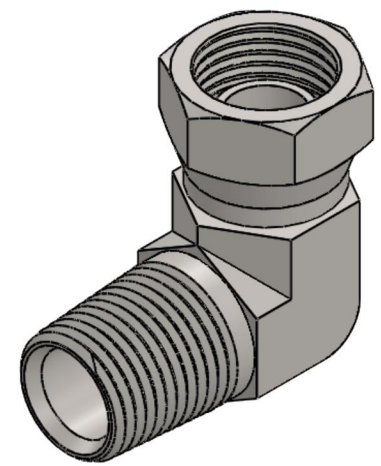
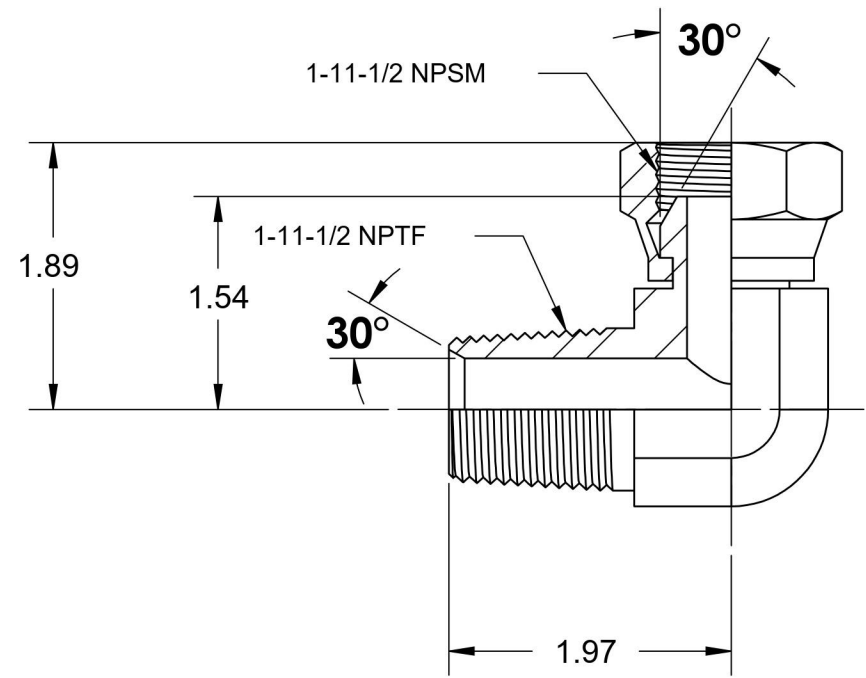
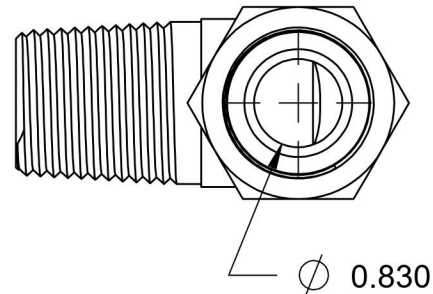
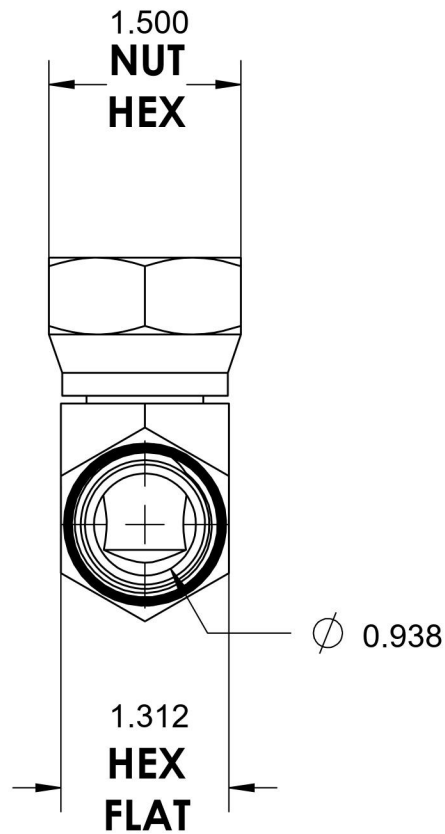

6701 Cochran Road
Solon, Ohio 44139
Phone: (440) 248-1880
Toll Free: 1-888-331-1523

Temperature Rating	-425°F to 1200°F	Material	316/316L Stainless Steel	Industry Standards	SAE J514, SAE J476	Series	1501-SS
Pressure Rating	2500 psi	Finish	Passivated			Series Description	SAE J514 NPSM Swivel 90° Male Elbow