

FS0304-C-32

Steel, SAE J1453 O-Ring Face Seal Cap, 2" ORFS Cap

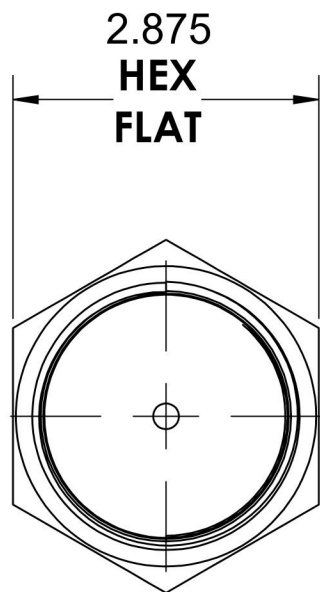

2-1/2-12 UN

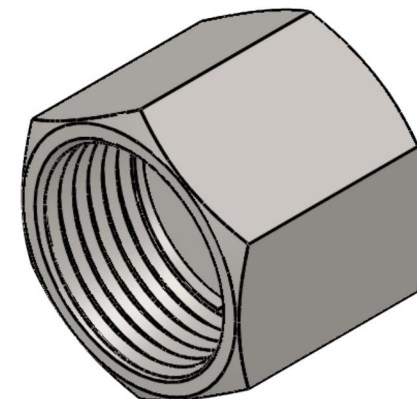
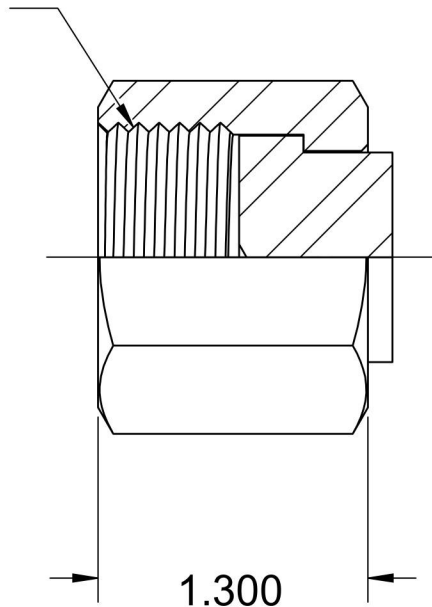

6701 Cochran Road
Solon, Ohio 44139
Phone: (440) 248-1880
Toll Free: 1-888-331-1523

Temperature Rating

-65°F to 500°F

Pressure Rating

3000 psi

Material

C1045/12L14 Steel

Finish

Trivalent Zinc

Industry Standards

SAE J1453, ASTM B633

Series

FS0304-C

Series Description

SAE J1453 O-Ring Face Seal Cap