

C2402-24-24

Steel, SAE J514 Flareless Tube Male Flared Adapter, 1-1/2" Flareless Bite Type x 1-1/2" Male JIC

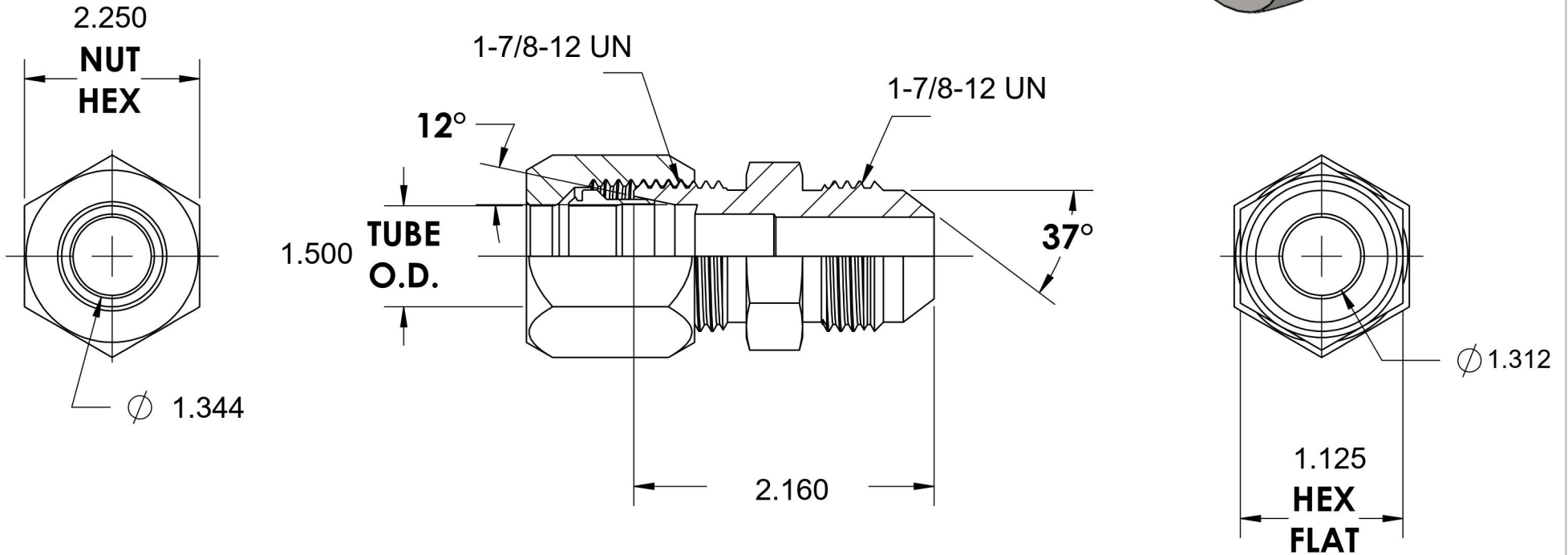
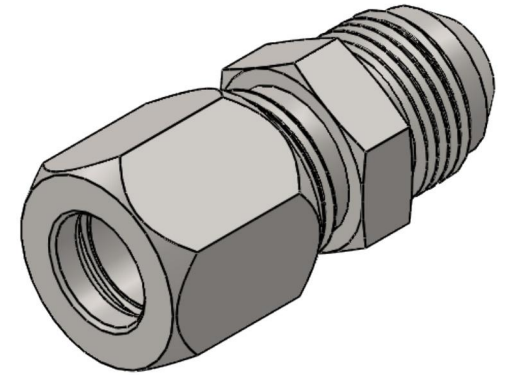

6701 Cochran Road
Solon, Ohio 44139
Phone: (440) 248-1880
Toll Free: 1-888-331-1523

Temperature Rating	Material	Industry Standards	Series
-65°F to 500°F	C1045/12L14 Steel	SAE J514, ASTM B633	C2402
Pressure Rating	Finish		Series Description
2000psi	Trivalent Zinc		SAE J514 Flareless Tube Male Flared Adapter