

FS7640-06-16-O

Steel, SAE J1453 O-Ring Face Seal Male Metric (ISO 6149) Port Connector, 3/8" Male ORFS x M16X1.5 Male Metric ORB

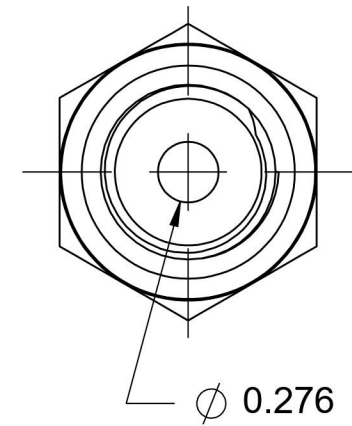
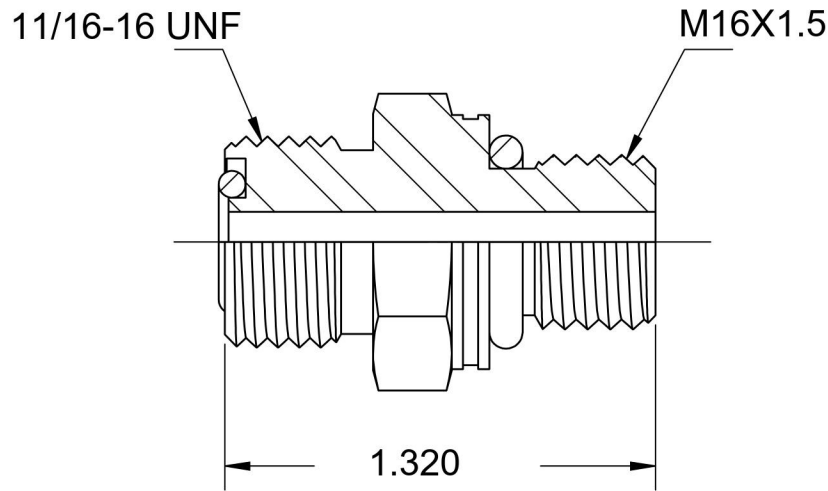
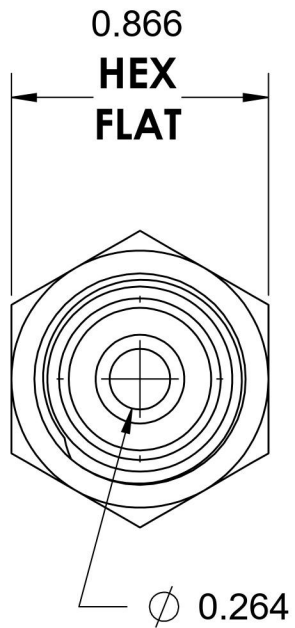
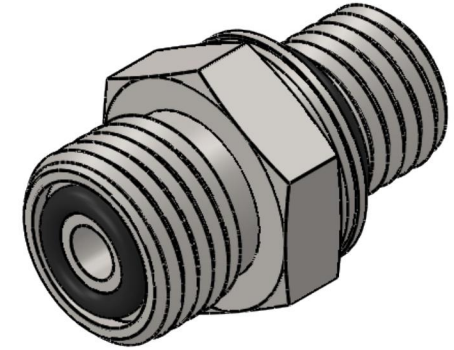

6701 Cochran Road
Solon, Ohio 44139
Phone: (440) 248-1880
Toll Free: 1-888-331-1523

Temperature Rating

-40°F to 250°F

Pressure Rating

9200 psi

Material

C1045/12L14 Steel

Finish

Trivalent Zinc

Industry Standards

SAE J1453, ISO 6149-2
SAE J515, ASTM B633

Series

FS7640-O-ISO 6149

Series Description

SAE J1453 O-Ring Face Seal
Male Metric (ISO 6149) Port Connector