

2701-04-04-B

Brass, SAE J514 37° Flare Bulkhead 90° Elbow, 1/4" Male JIC x 1/4" Male JIC

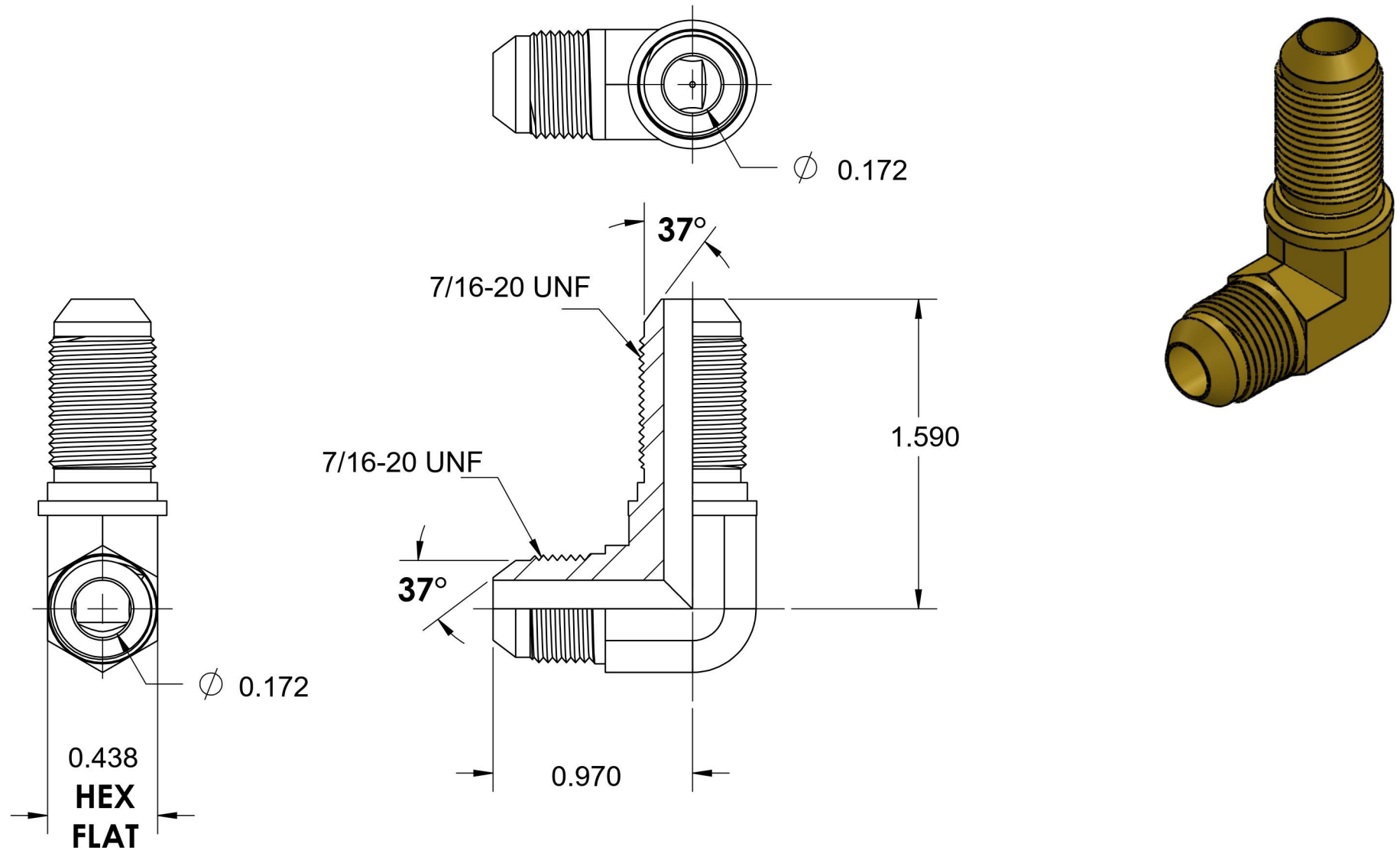

6701 Cochran Road
Solon, Ohio 44139
Phone: (440) 248-1880
Toll Free: 1-888-331-1523

Temperature Rating	Material	Industry Standards	Series
-325°F to 400°F	CA37700 Brass	SAE J514	2701-B
Pressure Rating	Finish		Series Description
3300 psi	Natural Finish		SAE J514 37° Flare Bulkhead 90° Elbow