

7005-06-14-SS-BS

Stainless Steel, SAE J514 37° Flare Metric Type (D) Bonded Seal Port/Line Connector, 3/8" Male JIC x M14X1.5 Male Metric 60° Line/Port

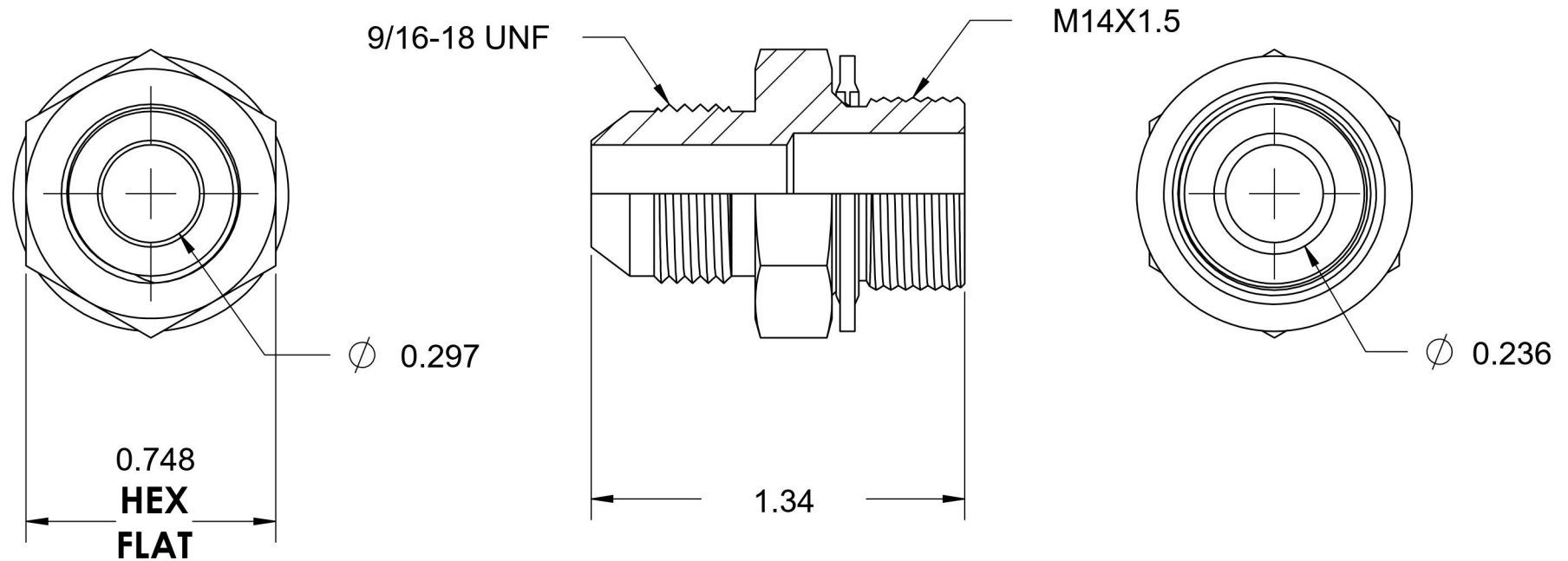
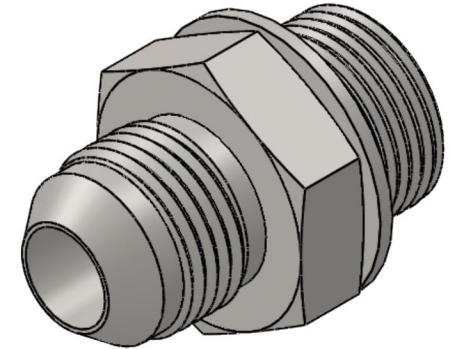

6701 Cochran Road
Solon, Ohio 44139
Phone: (440) 248-1880
Toll Free: 1-888-331-1523

Temperature Rating	Material	Industry Standards	Series
-40°F to 250°F	316/316L Stainless Steel	SAE J514, ISO 9974	7005-BS-SS
Pressure Rating	Finish		Series Description
6000 psi	Passivated		SAE J514 37° Flare Metric Type (D) Bonded Seal Port/Line Connector