

C0319-08-SS

Stainless Steel, SAE J514 Flareless Tube Ferrule, 1/2" Flareless Bite Type Sleeve Type A

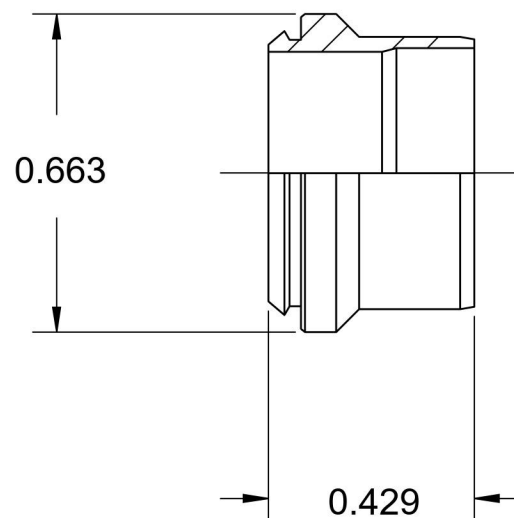
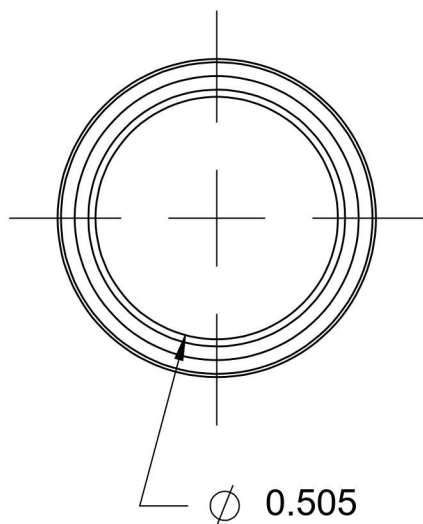

6701 Cochran Road
Solon, Ohio 44139
Phone: (440) 248-1880
Toll Free: 1-888-331-1523

Temperature Rating -425°F to 1200°F	Material 17-4 PH Stainless Steel	Industry Standards SAE J514	Series C0319
Pressure Rating Not Available	Finish Passivation		Series Description SAE J514 Flareless Tube Ferrule