

6400-04-10-O-SS

Stainless Steel, SAE J514 37° Flare Port Connector, 1/4" Male JIC x 7/8-14 Male ORB

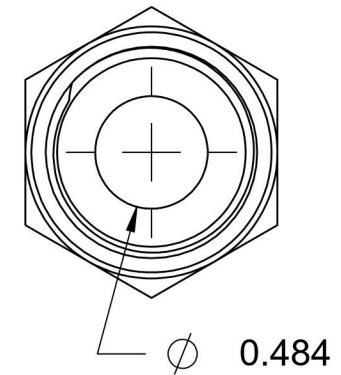
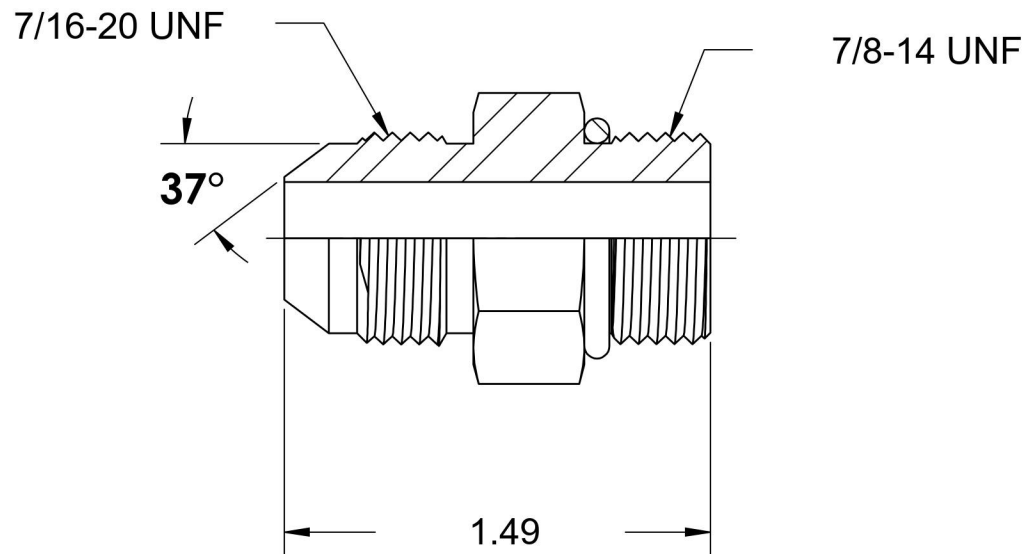
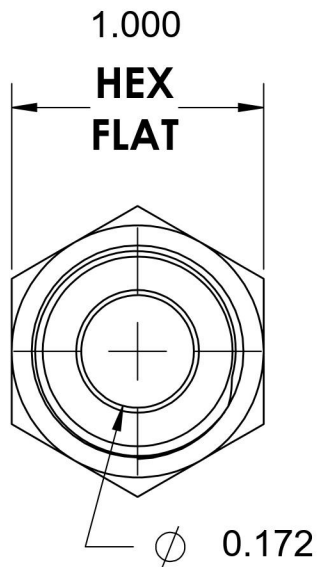
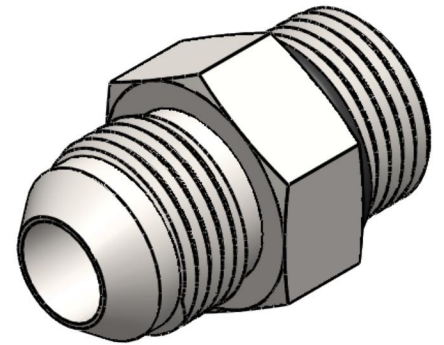

6701 Cochran Road
Solon, Ohio 44139
Phone: (440) 248-1880
Toll Free: 1-888-331-1523

Temperature Rating

-40°F to 250°F

Pressure Rating

6000 psi

Material

316/316L Stainless Steel

Finish

Passivated

Industry Standards

SAE J514, SAE J1926-3

Series

6400-O-SS

Series Description

SAE J514 37° Flare Port Connector