

# 7030-08-12

Steel, SAE J476 Pipe Male BSPT Nipple, 1/2" Male NPTF 30° x 3/4" Male BSPT

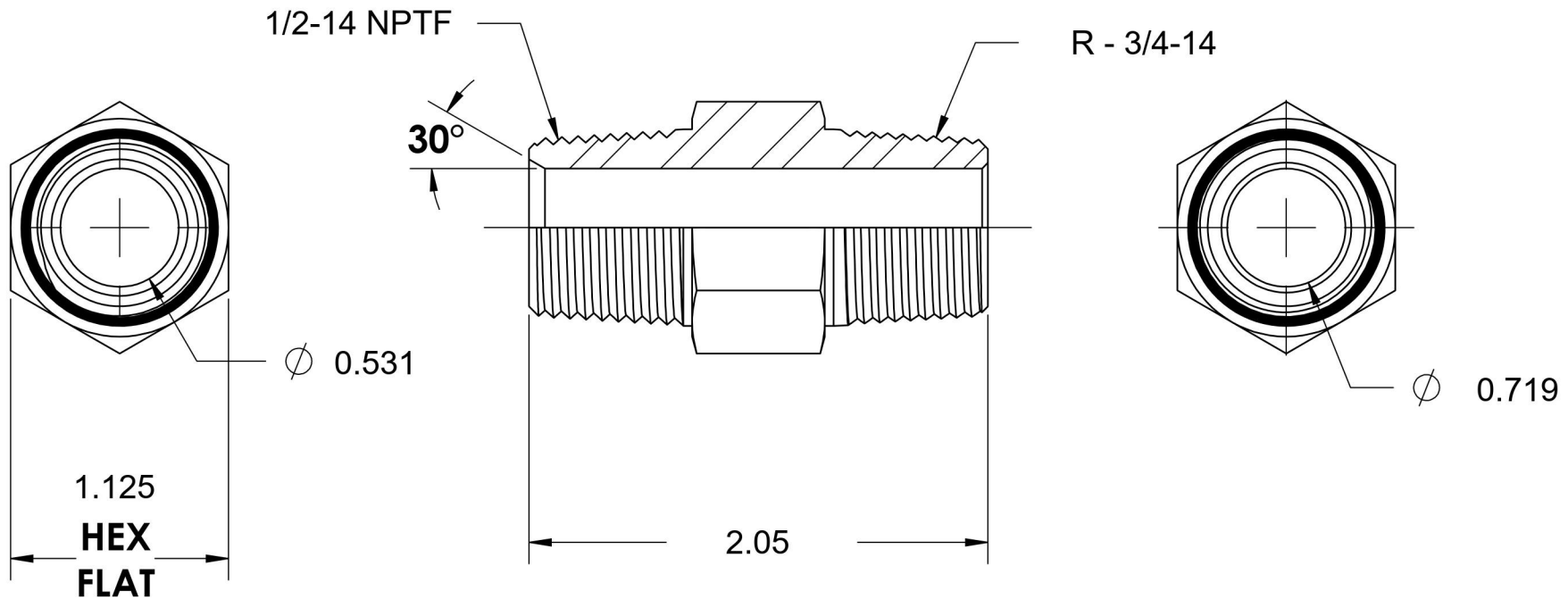

6701 Cochran Road  
Solon, Ohio 44139  
Phone: (440) 248-1880  
Toll Free: 1-888-331-1523

<b>Temperature Rating</b>	<b>Material</b>	<b>Industry Standards</b>	<b>Series</b>
-65°F to 500°F	C1045 / 12L14 Steel	SAE J476, ISO 7-1	7030
<b>Pressure Rating</b>	<b>Finish</b>	ASTM B633	<b>Series Description</b>
5500 psi	Trivalent Zinc		SAE J476 Pipe Male BSPT Nipple