

# D0304-C-L10-SS

Stainless Steel, DIN 2353 Blanking Plug, Light 10mm Tube OD

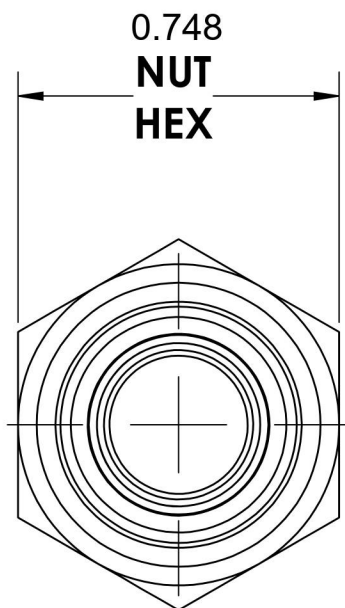

M16X1.5

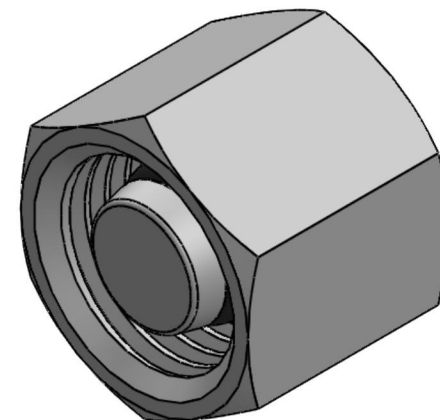
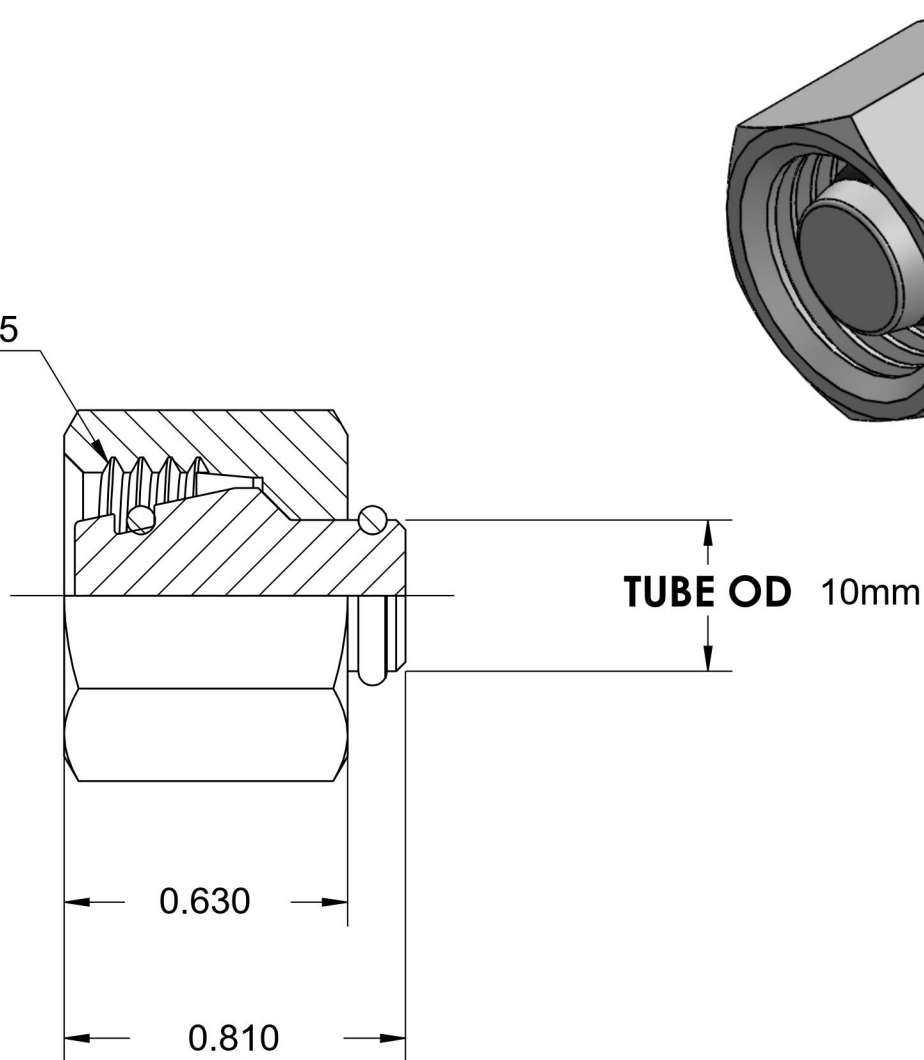

6701 Cochran Road  
Solon, Ohio 44139  
Phone: (440) 248-1880  
Toll Free: 1-888-331-1523

**Temperature Rating**

-15°F to 400°F

**Pressure Rating**

Not Available

**Material**

316Ti Stainless Steel

**Finish**

Passivated

**Industry Standards**

DIN 2353, ISO 8434-1

**Series**

D0304-C-SS

**Series Description**

DIN 2353 Flareless Tube  
Blanking Cap Assembly