

7007-20-S38-52

Steel, SAE J514 37° Flare DIN (S) Swivel Adapter, 1-1/4" Male JIC x M52X2.0 Female DKO Swivel

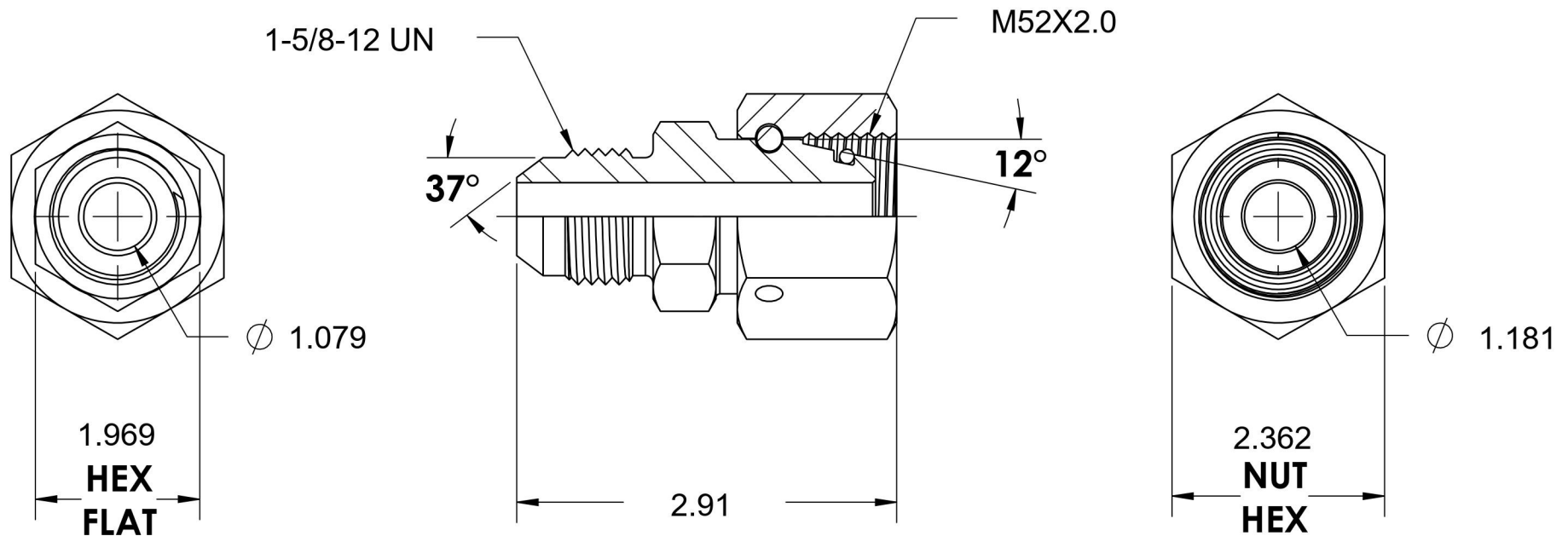

6701 Cochran Road
Solon, Ohio 44139
Phone: (440) 248-1880
Toll Free: 1-888-331-1523

Temperature Rating	Material	Industry Standards	Series
-40°F to 250°F	C1045 / 12L14 Steel	SAE J514, ISO 8434-1	7007-DIN HEAVY
Pressure Rating	Finish	DIN 2353, ASTM B633	Series Description
4000 psi	Trivalent Zinc		SAE J514 37° Flare DIN (S) Swivel Adapter