

7005-12-L15-22

Steel, SAE J514 37° Flare DIN 2353 (Light) Tube Adapter Body Only, 3/4" Male JIC x M22X1.5 Male DIN

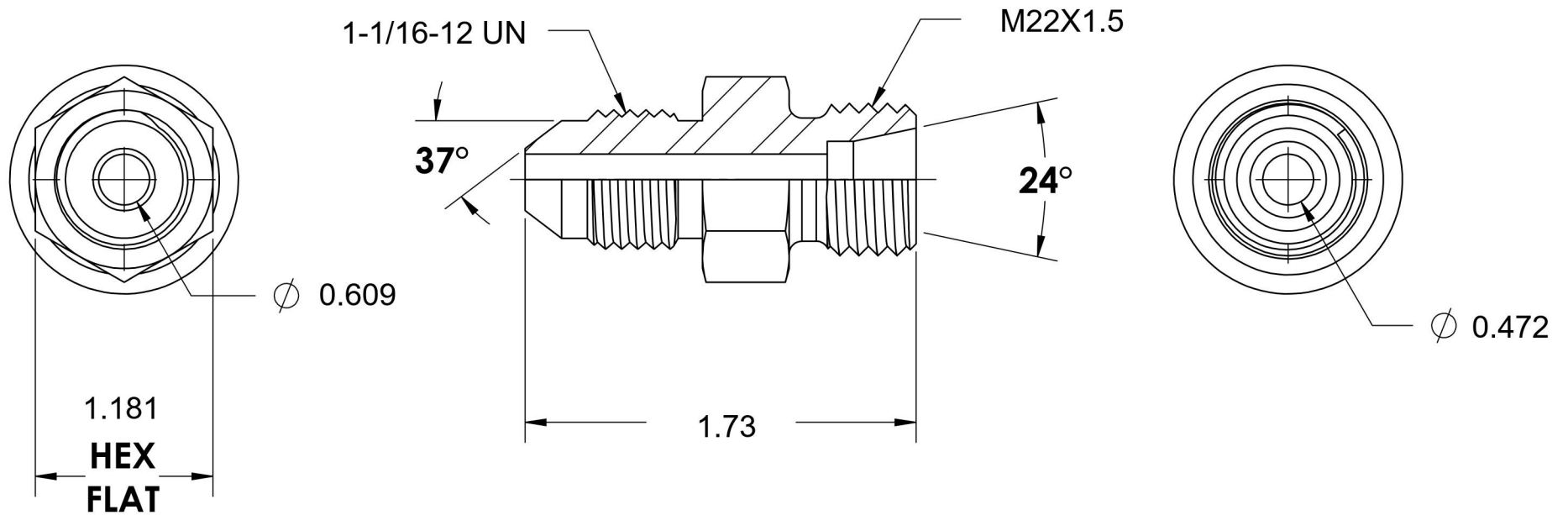
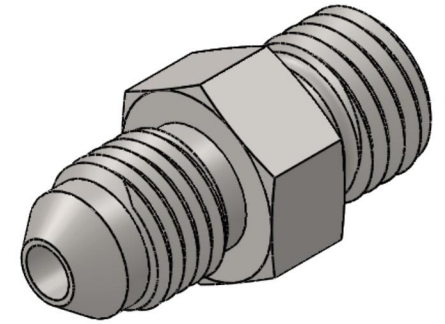

6701 Cochran Road
Solon, Ohio 44139
Phone: (440) 248-1880
Toll Free: 1-888-331-1523

Temperature Rating -65°F to 500°F	Material C1045 / 12L14 Steel	Industry Standards SAE J514, ISO 8434-1	Series 7005-DIN LIGHT
Pressure Rating 5000 psi	Finish Trivalent Zinc	Industry Standards DIN 2353, ASTM B633	Series Description SAE J514 37° Flare DIN 2353 (Light) Tube Adapter Body Only