

5503-08-08-SS

Stainless Steel, SAE J514 Pipe 45° Street Elbow, 1/2" Male NPTF 30° x 1/2" Female NPTF

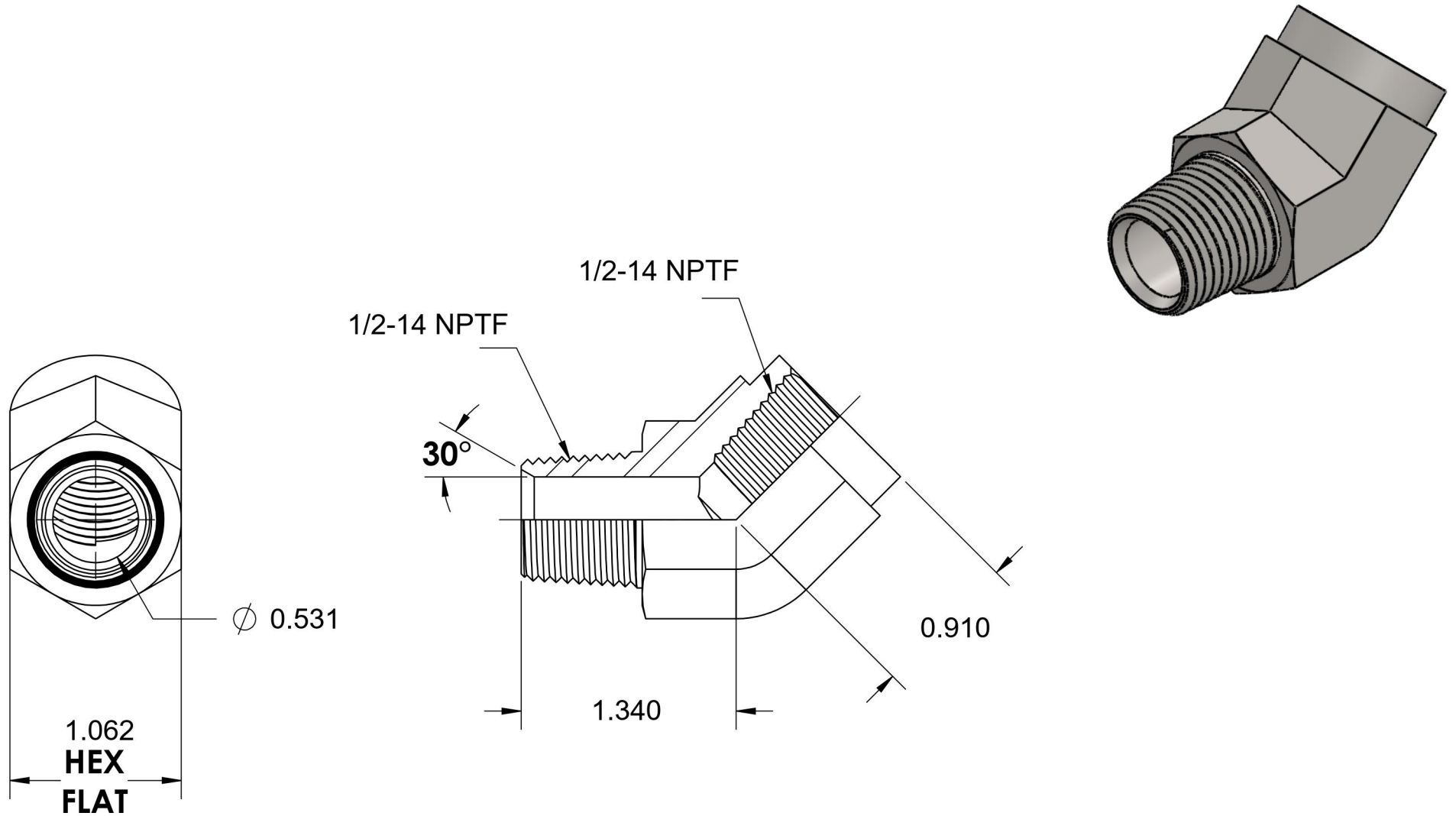

6701 Cochran Road
Solon, Ohio 44139
Phone: (440) 248-1880
Toll Free: 1-888-331-1523

Temperature Rating

-425°F to 1200°F

Pressure Rating

3000 psi

Material

316/316L Stainless Steel

Finish

Passivated

Industry Standards

SAE J514, SAE J476

Series

5503-SS

Series Description

SAE J514 Pipe 45° Street Elbow