

7023-08-08-SS

Stainless Steel, SAE J514 37° Flare Swivel BSPP Connector, 1/2" Female JIC Swivel x 1/2-14 Female BSPP Swivel

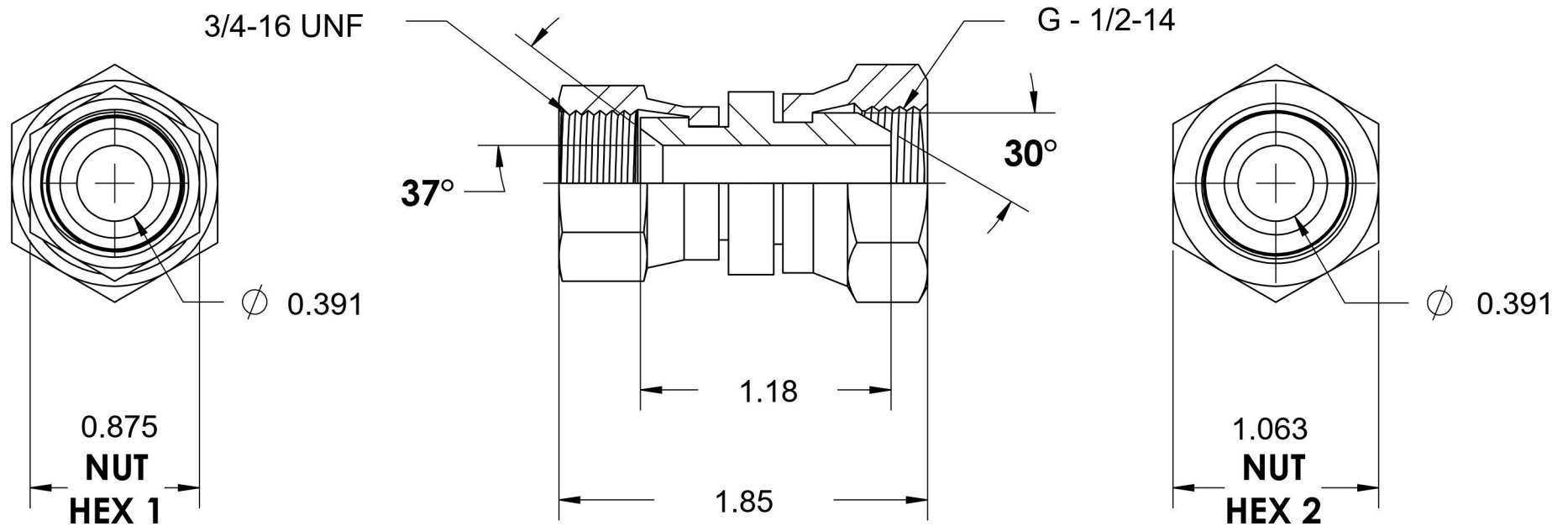
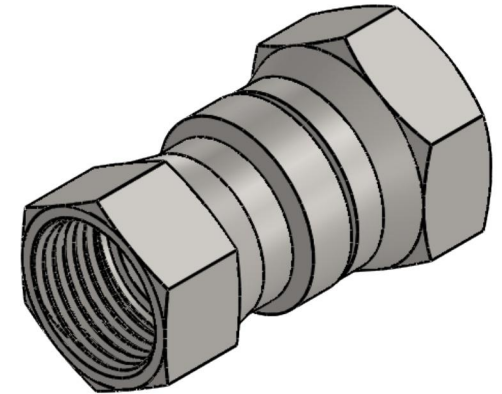

6701 Cochran Road
Solon, Ohio 44139
Phone: (440) 248-1880
Toll Free: 1-888-331-1523

Temperature Rating	Material	Industry Standards	Series
-425°F to 1200°F	316/316L Stainless Steel	SAE J514, ISO 8434-6	7023-SS
Pressure Rating	Finish	Series Description	
2900 psi	Passivated	SAE J514 37° Flare Swivel BSPP Connector	