

6565-10-06

Steel, SAE J514 37° Flare Swivel Union, 5/8" Female JIC Swivel x 3/8" Female JIC Swivel

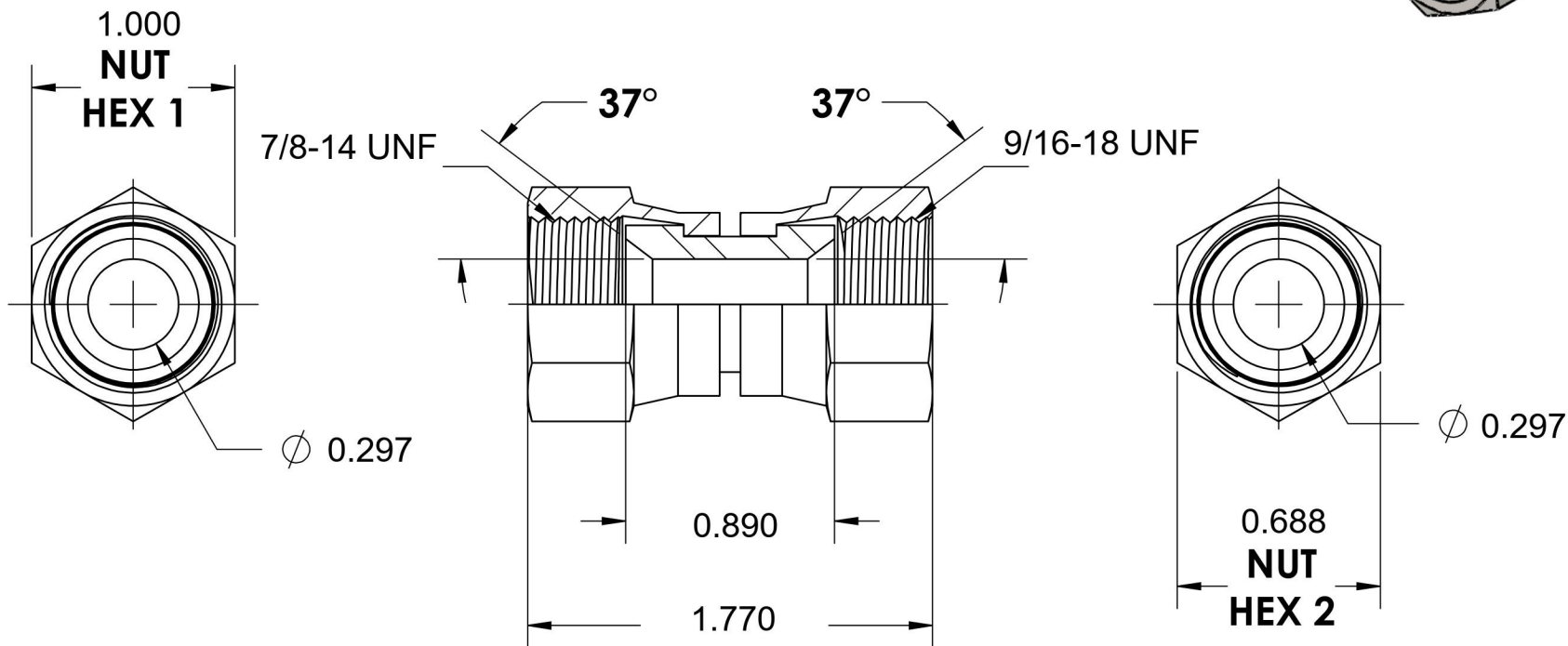
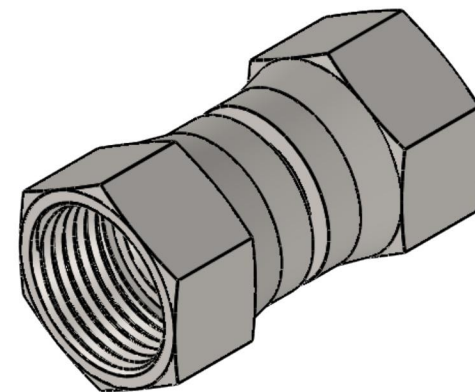

6701 Cochran Road
Solon, Ohio 44139
Phone: (440) 248-1880
Toll Free: 1-888-331-1523

Temperature Rating

-65°F to 500°F

Pressure Rating

5000 psi

Material

C1045/12L14 Steel

Finish

Trivalent Zinc

Industry Standards

SAE J514, ASTM B633

Series

6565

Series Description

SAE J514 37° Flare Swivel Union